

Integrity
Honesty
Enterprising spirit
Preciseness
Innovation
Win-win Cooperation



长鑫实业有限公司
EVERGOLD HOLDING CO., LTD

Add: Rm 2402 No.3 Building, No.17 Donghai Middle Road
Shinan Qingdao, 266071, China
Tel: 0086-0532-85953753 Fax: 0086-0532-85881954
Email: sales@eg-holding.com
Web: www.eg-holding.com

OIL PUMP



长鑫实业有限公司

EVERGOLD HOLDING CO., LTD

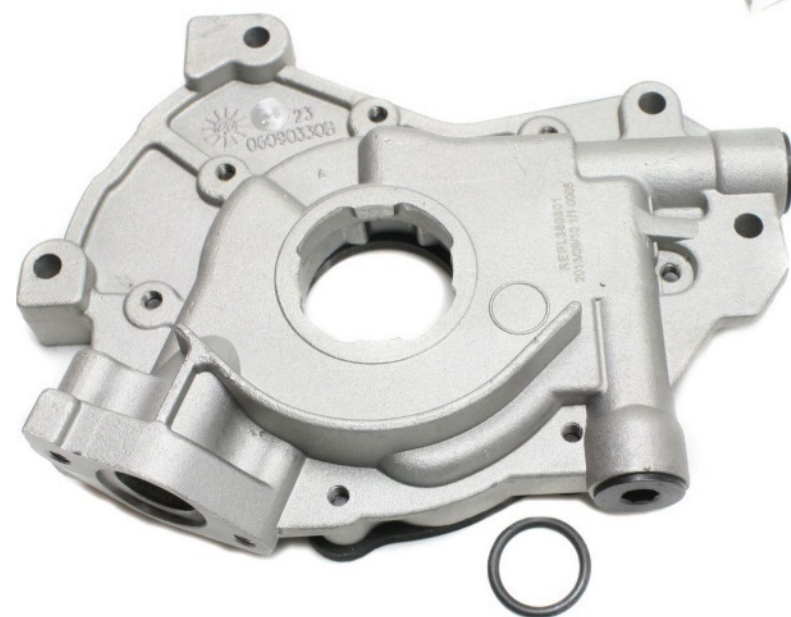

Best quality
Best service



CONTENTS













ALFA ROMEO	阿尔法罗密欧系列	001-001
AUDI	奥迪系列	002-006
BMW	宝马系列	007-007
BUICK	别克系列	008-009
CHRYSLER	克莱斯勒系列	010-012
DAIHATSU	大发系列	013-013
DAEWOO	大宇系列	014-014
DEUTZ	道依茨系列	015-016
DODGE	道奇系列	017-017
FIAT	菲亚特系列	018-023
FORD	福特系列	024-032
HONDA	本田系列	033-035
HYUNDAI	现代系列	036-037
ISUZU	五十铃系列	038-039
KIA	起亚系列	040-040
LADA	拉达系列	041-041
LAND ROVER	路虎系列	042-042
MAZDA	马自达系列	043-044
MERCEDES-BENZ	奔驰系列	045-047
MITSUBISHI	三菱系列	048-053
MWM	曼海姆系列	054-054
NISSAN	尼桑系列	055-059
OPEL	欧宝系列	060-065
PEUGEOT	标致系列	066-069
RENAULT	雷诺系列	070-073
SUZUKI	铃木系列	074-074
TOYOTA	丰田系列	075-082
VOLKSWAGEN	大众系列	083-089
OTHERS	其它车型	090-107

EGNO. PHOTO OEM NO. APPLICATION YEAR ACCESSORIES

EGNO.	PHOTO	OEM NO.	APPLICATION	YEAR	ACCESSORIES
EG-AL101		60568766			<input checked="" type="checkbox"/> Bolt 













OIL PUMP

EGNO. PHOTO OEM NO. APPLICATION YEAR ACCESSORIES

EGNO.	PHOTO	OEM NO.	APPLICATION	YEAR	ACCESSORIES
EG-AU101		111115107BK M79C	VW Transporter type 1 - 1.5/ 1.6 VW Transporter type 2 - 1.5/ 1.6 For air-cooled engines With holes for 8mm studs, 4mm flange and 26mm gears	71/80 71/92	<input checked="" type="checkbox"/> Gasket 
EG-AU102		111115107AK	VW Transporter type 1 - 1.5/ 1.6 VW Transporter type 2 - 1.5/ 1.6 For air-cooled engines With holes for 8mm studs, 4mm flange and 21mm gears	70/86 69/71	<input checked="" type="checkbox"/> Gasket 
EG-AU103		111115107AKHD	VW Transporter 1 1.5/ 1.6 For air-cooled engines With holes for 8mm studs, 8mm flange and 26mm gears	69/71	<input checked="" type="checkbox"/> Gasket 
EG-AU104		111115107AKSHD	VW Transporter 1 1.3/ 1.6 For air-cooled engines With holes for 8mm studs, 12mm flange and 30mm gears	69/71	<input checked="" type="checkbox"/> Gasket 
EG-AU105		111115107BKHD	VW Transporter type 1-1.3/ 1.6 For air-cooled engines With holes for 8mm studs, 8mm flange and 30mm gears	71/79	<input checked="" type="checkbox"/> Gasket 
EG-AU106		311115107AK M79A	Fusca1.3/1.5/1.6 BrasliaSTD./LS 1.5/1.6 Gol BX 1.3/1.6 Kombi STD./ Carat/ Furgol/ Pick-up/ 1.3/1.5/1.6 VW Transporter 1/2 1.5/ 1.6 with holes for 8mm studs, 8mm flange and 21mm gears	67/96 73/82 80/83 57/ 67/69	<input checked="" type="checkbox"/> Gasket 











OIL PUMP

EGNO. PHOTO OEM NO. APPLICATION YEAR ACCESSORIES

EG-AU107		311115107AKHD	Fusca 1.3/1.5/1.6 BrasiliaSTD./LS 1.5/1.6 Gol-BX - 1.3/ 1.6 KombiSTD/Carat/Furgao/ Pick-up - 1.3/ 1.5/ 1.6 with holes for 8mm studs, 12mm flange and 26mm gears	72/96 73/82 80/83 57/	<input checked="" type="checkbox"/> Gasket 
EG-AU108		034115105A 034115105D	AUDI 100 KU/RT/MC/NF 2.0 LITER 2.2 LITER	84	<input checked="" type="checkbox"/> Gasket 
EG-AU109		036115105B 036115105D 030115105N 030115105P	A2 (8Z0) 1.4, 1.4 TDI Arosa (6H) 1.0, 1.4, 1.4 16V Ibiza II (6K1) 1.0 i, 1.4 i Cordoba (6K2) 1.0 16V Inca (9KSF) 1.4 16V, 1.4 i, 1.6 i Leon (1M1) 1.4 16V, 1.6 16 V Toledo II (1M2) 1.4 16V, 1.6 16V Octavia (1U2) 1.4 16V Fabia (6Y2) 1.4 16V Toledo II (1M2) 1.4 16V, 1.6 16V	2000 97 93/99 99/02 95 99 99 96 99 99	<input checked="" type="checkbox"/> Gasket 
EG-AU110	 Chain Gear:31 Teeth	06A115105 M367	Golf - 1.6/ 2.0 / 2.0 Confortorline Golf GTI - 1.8 Turbo Golf A4 1.8 / 2.0L Golf A4 - 1.6 8V (importado) New Beetle - 2.0 8V Audi A3 - 1.6 / 1.6L / 1.8L Audi A3 - 1.8 / 1.8 Turbo Passat - 1.8 Variant - 1.8 Bora - 2.0 Bora - 2.0 Confortorline 8v Vario AKL - 1.6 8v Cordoba AKL - 1.6 8v Ibiza AKL 1.6 8v Polo 2.0	99/ 00/ 01/ 98 98 99/ 99/ 00/ 01/ 01/ 01/ 00/ 99/ 99/	<input checked="" type="checkbox"/> Gasket 
EG-AU111		078115105A 078115105D	80 Cabrio (8G7, B4) 2.6, 2.8 A4 (8D2, B5) 2.4, 2.4 quattro, 2.6, 2.6 quattro, 2.8, 2.8 quattro A4 Avant (8D5, B5) 2.4, 2.4 quattro, 2.6, 2.6 quattro, 2.8, 2.8 quattro A4 (8E2, B6) 2.4 A4 Avant (8E5, B6) 2.4 A4 Cabrio (8H7) 2.4 A6 (4B, C5) 2.4, 2.4 quattro, 2.7 T, 2.7 T quattro, 2.8, 2.8 quattro A8 (4D2, 4D8) 02.8, 2.8 quattro	91/00 95/00 95/01 00/04 01/04 2 0 0 4 2 0 0 2 97/05	<input checked="" type="checkbox"/> Gasket 
EG-AU112		069115105Q			<input checked="" type="checkbox"/> Gasket 









OIL PUMP

EGNO. PHOTO OEM NO. APPLICATION YEAR ACCESSORIES





EG-AU113	 Chain Gear:31 Teeth	06A115105B	Golf - 1.6/ 2.0 / 2.0 Golf GTI - 1.8 Turbo Golf A4 1.8 / 2.0L Golf A4 - 1.6 8V (importado) New Beetle - 2.0 8V Audi A3 - 1.6 / 1.6L / 1.8L Audi A3 - 1.8 / 1.8 Turbo Passat - 1.8 Variant - 1.8 Bora - 2.0 Bora - 2.0 Confortorline 8v Vario AKL - 1.6 8v Cordoba AKL - 1.6 8v Ibiza AKL - 1.6 8v Polo 2.0	99/ 00/ 01/ 08-98 /07-99 99/ 99/ 00/ 01/ 01/ 99/ 05-02	<input checked="" type="checkbox"/> Gasket 
EG-AU114		074115105A 074115105B 074115105D	100 (4A, C4) 2.5 TDI 100 Avant (4A, C4) 2.5 TDI A6 (4A, C4) 2.5 TDI, 2.5 TDI quattro A6 Avant (4A, C4) 2.5 TDI, 2.5 TDI quattro	90/94 90/94 94/97 94/97	<input checked="" type="checkbox"/> Gasket 
EG-AU115		078115109A			
EG-AU116		078115103D	80 (8C, B4) 2.6, 2.6 quattro, 2.8, 2.8 quattro 80 Avant (8C, B4) 2.6, 2.6 quattro, 2.8, 2.8 quattro 80 Cabrio (8G7, B4) 2.6, 2.8 Coup (89, 8B) 2.6, 2.6 quattro, 2.8, 2.8 quattro A4 (8D2, B5) 2.4, 2.6, 2.6 quattro, 2.8, A4 Avant (8D5, B5) 2.4, 2.6, 2.6 quattro, 2.8, A6 (4A, C4) 2.6, 2.6 quattro, 2.8, 2.8 quattro A6 Avant (4A, C4) 2.6, 2.6 quattro, 2.8, 2.8 quattro A8 (4D2, 4D8) 2.8, 2.8 quattro	91/94 91/96 91/00 88/96 95/00 95/01 94/97 94/97 94/02	<input checked="" type="checkbox"/> Gasket 
EG-AU117		069115105J 069115105 069115105B 073115105	Audi100 CN 2 Audi100 DE 2 Audi100 Avant CN 2 DE 2 VW LT 28 Bus CP 2,4 DL 2,4 VW LT 28 Bus DV 2,4 DW 2,4 VW LT 28 Bus HS 2,4 1E 2,4 VW LT 28 Bus 1G 2,4 1S 2,4		<input checked="" type="checkbox"/> Gasket 
EG-AU118		077115103E	100 (4A, C4) S4 V8 quattro 100 Avant (4A, C4) S4 V8 quattro A6 (4A, C4) S6 4.2 quattro A6 Avant (4A, C4) S6 4.2 quattro A8 (4D2, 4D8) 3.7, 3.7 quattro, 4.2 quattro, S 8 quattro V8 (D1)	90/94 90/94 94/97 94/97 94/02 88/94	

OIL PUMP





EGNO. PHOTO OEM NO. APPLICATION YEAR ACCESSORIES

EG-AU119		052115105B	50 LS/GLS HB/HC/HD 50LS/GLS HH FY/FZ 80 1.3 ZA/ZF/YJ 8VSOHC	75/88 80/83 78/83	
EG-AU120		034115105B	AUDI 100KU/RT/MC/NF 2.0 LITER 2.2 LITER	84	<input checked="" type="checkbox"/> Gasket 
EG-AU121		113115107IA	BOMBA DE DLEO PARA MOTORES 1300 CC /1500 CC /1600CC With holes for 8mm studs, 8mm flange and 21mm gears	67/73	<input checked="" type="checkbox"/> Gasket 
EG-AU122		311115107FV	BOMBA DE DLEO PARA MOTORES 1300 CC /1500 CC /1600CC With holes for 8mm studs, 12mm flange and 26mm gears	72	<input checked="" type="checkbox"/> Gasket 
EG-AU123					
EG-AU124			Iron Casting		

EGNO. PHOTO OEM NO. APPLICATION YEAR ACCESSORIES









EG-AU125		03L115105C			
EG-AU126	 Chain Gear:31 Teeth	038115105D			
EG-AU127		06E115105			
EG-AU128	 Chain Gear: 23 Teeth	038115105C	AUDI A3 1.9/2.0 TDI (8P1) AUDI A3 Cabriolet 1.9TDI (8P7) AUDIA3Sportback 1.9/2.0TDI(8PA) SEAT ALTEA 1.9/2.0TDI(5P1) SEAT ALTEA XL 1.9/2.0TDI(5P5,5P8) SEAT CORDOBA 1.9TDI(6L2) SEAT IBIZA IV 1.9TDI(6L1) SEAT IBIZA V 1.9TDI(6J5) SEAT IBIZA VSPORTCOUPE 1.9TDI (6J1) SEAT LEON 1.9/2.0 TDI (1P1) SEAT TOLEDO III 1.9/2.0TDI(5P2) SKODA (1Z3, 1Z5,5J,3T4,5L) VOLKSWAGEN(2KA,2KH,2CA,2CH, 2KB,2KJ,2CB,2CJ,1F7,1F8,5M1,521, 1K1,1K5,5K1,1K2,3C2,3C5,137,1T1, 1T2)		

EGNO. PHOTO OEM NO. APPLICATION YEAR ACCESSORIES

EGNO.	PHOTO	OEM NO.	APPLICATION	YEAR	ACCESSORIES
EG-BM101		114117401154 11411740965 11411740967			
EG-BM102		11411286468 11411267384			
EG-BM103		11411286493 11411262435 11411267198 11411267383 11411274491	BM5 E28 528 518I BM3 E21 315 316 318 318I BM3 E30 316 316I 318 318I M3 2.3 318		
EG-BM104		11411748146			

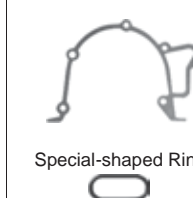

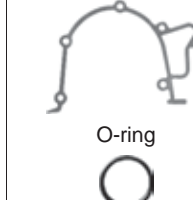
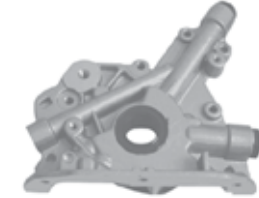
OIL PUMP

EGNO. PHOTO OEM NO. APPLICATION YEAR ACCESSORIES













EGNO.	PHOTO	OEM NO.	APPLICATION	YEAR	ACCESSORIES
EG-BK101		12640448			<input type="checkbox"/> Clip 
EG-DE101B	 Aluminium Back Plate	96386934 M275			<input checked="" type="checkbox"/> Gasket 
EG-OP107		24406585 90570980 09129092 93287137 0646067	PARAMOTORES VECTRA2.0 16V VECTRA2.2 16V ASTRA2.0 16V ZAFIRA2.0 16V	99	<input checked="" type="checkbox"/> Gasket  Special-shaped Ring
EG-OP108		90570925 90499157	Bomba para motors ohc 2000 Vectra astra pickup s10 Omega 2.2suprema 2.2 Blazer 2.2 Kaddet Ipanema gl/gls2.0	93	<input checked="" type="checkbox"/> Gasket  O-ring
EG-OP110		93293030	GM L4 1.4L (85), 1.6L (96) SOHC 8 Vál. 1994-12, Chevy, C2, Pop, Swing, Monza, Pick Up, Station Wagon		<input checked="" type="checkbox"/> Gasket 
EG-O10		10118639 M134	GM V6 2.8L (173), 3.1L (189), 3.4L (207), 1990-09, Century, Regal, Rendezvous, Beretta, Camaro, Cavalier, Impala, Lumina, Malibu, Monte Carlo, Uplander, Venture, Equinox, S-10, S-15, Pick-Up, Cutlass, Silhouette, Aztek, Firebird, Grand Am, Grand Prix, Montana, Torrent, Trans Sport		

OIL PUMP

EGNO. PHOTO OEM NO. APPLICATION YEAR ACCESSORIES

EGNO.	PHOTO	OEM NO.	APPLICATION	YEAR	ACCESSORIES
EG-O17		12606580 12584621 12606590 90537914	GM L4 2.2 SOHC, DOHC Astra, Zafira, Vectra	2000-2009	
EG-O26		12579555 12591997 12591990	BUICK REGAL 3.0		

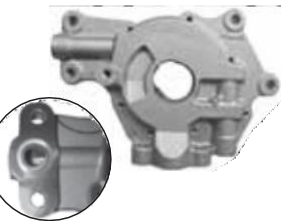
EGNO. PHOTO OEM NO. APPLICATION YEAR ACCESSORIES



EGNO.	PHOTO	OEM NO.	APPLICATION	YEAR	ACCESSORIES
EG-CR101		4663747 4663744 4663745 4663750 M296	CHRYSLER 300 V6-2.7L CHRYSLER CONCORDE V6-2.7L CHRYSLER INTREPID V6-2.7L CHRYSLER SEBRING V6-2.7L DODGE CHARGER V6-2.7L DODGE INTREPID V6-2.7L DODGE MAGNUM V6-2.7L DODGE STRATUS V6-2.7L	07-05 04-98 04-98 07-01 07-06 04-98 07-05 06-01	
EG-CR102					
EG-CR103		04884390AB	CHRYSLER PT CRUISER L4-2.4L DODGE NEON L4-2.4L	07-03 05-04	<input checked="" type="checkbox"/> O-ring 
EG-CR104		OPC30	CHRYSLER SEBRING L2-2.4L CHRYSLER VOYAGER L4-2.4L DODGE CARAVAN L4-2.4L DODGE STRATUS L4-2.4L	04-01 03-01 04-01 04-01	<input checked="" type="checkbox"/> O-ring 
EG-CR105		OPC30PT			<input checked="" type="checkbox"/> O-ring 
EG-CR106		OP143			<input checked="" type="checkbox"/> Gasket 
EG-CR107		4663747 4663744 4663745 4663750 M296	CHRYSLER 300 V6-2.7L CHRYSLER CONCORDE V6-2.7L CHRYSLER INTREPID V6-2.7L CHRYSLER SEBRING V6-2.7L DODGE CHARGER V6-2.7L DODGE INTREPID V6-2.7L DODGE MAGNUM V6-2.7L DODGE STRATUS V6-2.7L	07-05 04-98 04-98 07-01 07-06 04-98 07-05 06-01	<input checked="" type="checkbox"/> O-ring 









EGNO.	PHOTO	OEM NO.	APPLICATION	YEAR	ACCESSORIES
EG-CR108		2806270 4071040 4626055 53009295 M72	STANDARD 273-360 V8 360	1964-2003	<input checked="" type="checkbox"/> Gasket
EG-CR109		4298537 4323626 4397746 4397746AB 4379827 4442295 4626695 4667379 M118			<input checked="" type="checkbox"/> O-ring
EG-CR110		OP1156 M345	CHRYSLER 300 V6-3.5L CHRYSLER PACIFICA V6-4.0L CHRYSLER SEBRNG V6-3.5L CHRYSLER TOWN& COUNRTY V6-4.0L DODGE AVENGER V6-3.5L DODGE CHALLENGER V6-3.5L DODGE CHARGER V6-3.5L DODGE GRAND CARAVAN V6-4.0L DODGE JOURNEY V6- 3.5L DODGE MAGNUM V6-3.5L DODGE NITRO V6-4.0L	10-08 08-07 10-07 10-08 10-08 10-09 10-08 10-08 10-09 2008 10-07	<input checked="" type="checkbox"/> Gasket
EG-CR111		OP1150 M421			<input checked="" type="checkbox"/> Gasket O-ring Bush
EG-CR112		OP1150A M441	CHRYSLER PACIFICA V6-3.5L	06-05	<input checked="" type="checkbox"/> Gasket O-ring Bush
EG-CR113		OP1151	CHRYSLER 300 V6-3.5L DODGE CHARGER V6-3.5L DODGE MAGNUM V6-3.5L	07-05 07-06 07-05	<input checked="" type="checkbox"/> Gasket





OIL PUMP

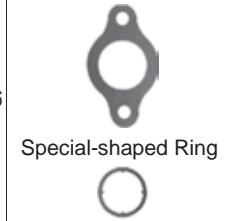
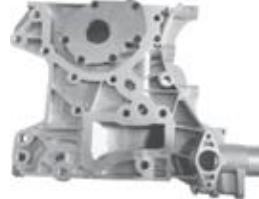

EGNO.	PHOTO	OEM NO.	APPLICATION	YEAR	ACCESSORIES
EG-CR114		04667884 4667884 4667884AC M190	CHRYSLER,EAGLE2000cc 4CYL,DOCH SOCH 16V 4A20,A588 ECLIPSE	1995-2000	<input checked="" type="checkbox"/> O-ring
EG-CR115		4694304 M247	CIRRUS 2400cc BREEZE 2400cc CARAVAN GRAND STRATUS SEBRING VOYAGER GRAND VOYAGER	1997-2002 1998-2000	<input checked="" type="checkbox"/> O-ring

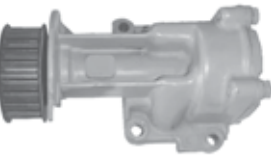







OIL PUMP







EGNO.	PHOTO	OEM NO.	APPLICATION	YEAR	ACCESSORIES
EG-DA101		1511087703	CHARADE,CX,CXL,993 S-75,HIJET 1000 CHARADE,G10,G11 G100,AC CB60	83/85	
EG-DA102		1510097212			

EGNO.	PHOTO	OEM NO.	APPLICATION	YEAR	ACCESSORIES
EG-DE101	 Iron Back Plate	96353242 90541505 96386460 96351059 96350159	CORSK/KADETT/VECTRA 14NV-16NV ASTRA/BELMONT/ CAVALIER NOVA ENG.14NV/16SV		<input checked="" type="checkbox"/> Gasket 
EG-DE101B	 Aluminium Back Plate	96386934 M275	GM L4 1.6L (2008-11) Aveo		<input checked="" type="checkbox"/> Gasket 
EG-DE102		16100A70B2300 160010810000 94580158	TICO MATIZI M100,M150	1998/2005	
EG-DE103		90298370 90298371			<input checked="" type="checkbox"/> Gasket 
EG-DE104		OP528	Suzuki Verona 2.5L L6	2004/2006	<input checked="" type="checkbox"/> Gasket  Special-shaped Ring
EG-DE105		55556428			



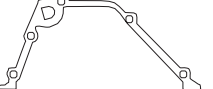



EGNO.	PHOTO	OEM NO.	APPLICATION	YEAR	ACCESSORIES
EG-DU101		2934430 M4430	F4L1011		
EG-DU102		4173018 4175573 M5573	F2/3L1011		
EG-DU103		4286878 04256853 M6878	BE4L1011F F4L1011F BF4M1011F F4M1011F		
EG-DU104		4102478 4280165 4287078 4280478 M478	TDC2011L03 BF3L2011 BF4LM2011 F4L2011 F4M2011		
EG-DU105		03365893	F6L614A		
EG-DU106		04280145	F2L2011 F3L2011 F2M2011 F3M2011		

EGNO.	PHOTO	OEM NO.	APPLICATION	YEAR	ACCESSORIES
EG-DU107		04270645 04270245 04178969 04179713	4L/4M1011		
EG-DU108	 Drive Gear: 25Teeth	04230651 04231307 04234145 04159964	F4L912		
EG-DU109	 Drive Gear: 25Teeth	04231309 04230653 04159951 04234146 04158341 04157674 02130385	F6L912		

EGNO.	PHOTO	OEM NO.	APPLICATION	YEAR	ACCESSORIES
EG-DO101		53020827AB 53020827 OP0601 M297	DODGE DAKOTA V8-4.7L DODGE DAKOTA V6-3.7L DODGE DURANGO V8-4.7L DODGE DURANGO V6-3.7L DODGE RAM 1500 TRUCK V8-4.7L DODGE RAM 1500 TRUCK V6-3.7L JEEP COMMANDER V8-4.7L JEEP COMMANDER V6-3.7L JEEP GRAND CHEROKEE V6-3.7L JEEP GRAND CHEROKEE V8-4.7L JEEP LIBERTY V6-3.7L MITSUBISHI RAIDER V8-4.7L MITSUBISHI RAIDER V6-3.7L	05-00 06-04 05-00 06-04 05-02 06-02 2 0 0 6 2 0 0 6 06-05 06-99 06-02 07-06 07-06	<input checked="" type="checkbox"/> O-ring 
EG-DO102		12563964 12586665 17801836 OP3165 M295	BUICK RAINIER V8-5.3L CADILLAC ESCALADE V8-5.3L CHEVROLET AVALANCHE 1500 V8-5.3L CHEVROLET CAMARO V8-5.7L CHEVROLET CORVETTE V8-5.7L CHEVROLET EXPRESS 3500 V8-4.8L CHEVROLET SILVERADO 3500 V8-6.0L CHEVROLET SSR V8-5.3L CHEVROLET SUBURBAN 2500 8-6.0L CHEVROLET TAHOE V8-4.8L CHEVROLET TRAILBLAZER V8-6.0L GMC ENVOY V8-5.3L GMC SAVANA 3500 V8-4.8L GMC SIERRA C3 2001 V8-6.0L GMC YUKON V8-5.3L GMC YUKON DENALI V8-6.0L GMC YUKON XL 1500 V8-5.3L HUMMER H2 V8-6.0L PONTIAC FIREBIRD V8-5.7L	2004 05-02 06-02 02-98 03-97 07-05 07-01 2003 06-00 06-00 08-06 04-03 07-04 04-02 06-00 06-01 06-00 07-03 02-98	<input checked="" type="checkbox"/> O-ring 
EG-DO103		4621894	DODGE CHRYSLER		
EG-DO104		OP1160 53021622AF	CHRYSLER 300 V8-5.7L DODGE CHARGER V8-5.7L DODGE DURANGO V8-5.7L DODGE MAGNUM V8-5.7L DODGE RAM 1500 TRUCK V8-5.7L DODGE RAM 2500 TRUCK V8-5.7L DODGE RAM 3500 TRUCK V8-5.7L JEEP COMMANDER V8-5.7L JEEP GRAND CHEROKEE V8-5.7L	07-05 07-06 07-04 06-05 07-03 07-03 07-03 07-06 07-05	
EG-DO105					
EG-DO106		OP1163 53021622	DURNAGO 5700cc CHARGER DOURANGO MAGNUM RAM 1500/2500/3500 TRUCK	2002-2007	<input checked="" type="checkbox"/> O-ring 









EGNO.	PHOTO	OEM NO.	APPLICATION	YEAR	ACCESSORIES
EG-FI101		4705827 804002 4654756 4602591	480-640 TRACTOR TRUCK ENGINE NC50 616/N2/3/3/ 4/4		
EG-FI102		4423006 43957367C	VAN FIORINO - 1.1 FIORINO PICK UP- FURGAO- PANORAMA-147	76-78	
EG-FI103		7588737 7588739	Uno 1.1 45 85/1.0 45 Tipo 1.1 156 A2/A4/Az Panda 0.75/1.0 Super Nova Fire 1.0	1985	<input checked="" type="checkbox"/> Gasket 
EG-FI104		4320885 4379251	124 1.2 124A/B SEAT124 125 SPORTS 125 A/B 1600 125 SPECIAL 241	1966	
EG-FI105		464667340 46467338 46467341 7610246	Tipo 1.4/1.6 146/160/A8 Tipo 1.3/1.5 Moderno 146/ 160 Tempra 1.4/1.6 146/160/A8 Nouva Fiorino 1.5 128 1.5 Berlina, Familiar	1988	
EG-FI106		4391376 46586680 46583287 5962426 7546794 7588958	128 1.1/4 128 1.3 128A/1 Regata 1.1/1.3/1.5 Ritmo 1.1/1.3/1.5 75L Strada 1.1/1.3/1.5 138 B000 Tipo 1.4/1.6 All Uno 1.2 SX /1.3 Turbo/1.3 70 138B2/1.4 Turbo/1.4 SX/1.5 SX	1974 1978 1984 1983 1988	

EGNO. PHOTO OEM NO. APPLICATION YEAR ACCESSORIES

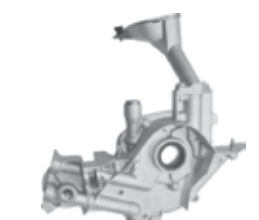
EG-FI107		4284907 4227634	127 1.0 100GL Fiorino 0.9 100GL Ritmo 1.3 65/70/75 138A/B 127 1.3 D 127 A5 Panda 1.0 100GL, 4x4 A112 X 1/9 All 128A5 / 138A2 Stada 1.0/1.1/1.5 Uno 1.0 45 146A/1.1 55 138B Cinquecento 0.9 Uno / Sting	1966 1978 1981 1978 1983 1972 1993	
EG-FI108		4395895 7555208	Duna 1.1 D Diesel 147 A6/A9 Nouva Fiorino 1.1 D /1.3 D Diesel Panda 1.3 D Diesel 147 Uno 1.0 D Diesel/1.1 D Diesel	1987	<input checked="" type="checkbox"/> Gasket 
EG-FI109		4419319 9905594	132 2 LITRE 242 2000 ARGENTA 2.0i 132C3 SPIDER VX2.0 232R 131 2000	1968 1981 1968	
EG-FI110		FA28			
EG-FI111		7533576	Uno - S 1.5/S 1.5 ie/ GS 1.5/ CS1.5 i.e/ Furgoneta 1.5 Elba - Weekend 1.5 Fiorino - Furgao / 1.5 / 1.5 ie /1.5 mpi Pick-up 1.5 / 1.5 ie / LX 1.5 / HD 1.5 Pick-up working 1.5 mpi / Pick-up Trekking 1.5 mpi Siena - 6 marchas 1.0 / 500 anos 1.0 Siena EL 1.5 / ELX 1.5 / City 1.5 Palio - EL 1.5 / ELX 1.5 / City 1.5 Palio - Weekend 1.5 / City 1.5 / ELX 1.5 / EX 1.5 Palio - Weekend 6 marchas 1.0 Strada - Working 1.5	91/94 90/ 91/90 89/ 99/00 99/00 98/ 96/00 97/00 99/00 99/ 01/	<input checked="" type="checkbox"/> Gasket 

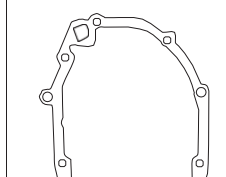







OIL PUMP

EGNO. PHOTO OEM NO. APPLICATION YEAR ACCESSORIES

EG-FI112		7758296 50004346	TEMPRA 2.0 / OURO 2.0 ie 16v / TURBO 2.0 ie / STILE TURBO 2.0 ie / SX 2.0 / SX 2.0 ie 16V / HLX 2.0 16V	93	<input checked="" type="checkbox"/> Gasket 
EG-FI113		73502291 46808707	PALIO ELX 1.0 FIRE 8V UNO-MILLE 1.0 MPI FIRE 8V SIENA 1.0 MPI FIRE 8V STRADA 1.3 MPI FIRE 8V	2000	
EG-FI114		46751173 55205942	FIAT PALIO/FIRE/DOBLO 1.0/1.3 16V		<input checked="" type="checkbox"/> Gasket 
EG-FI115		4199918			
EG-FI116		7588740 OT061221-02			
EG-FI117		7533630 7553391 9923174 OT061218-26	DUNA,RITMO, REGATTA1.7/2.0DS 149B3 UNO 1.4 TD 146B3 UNO 45 1.3DS/TD,17TD 146B2 FIORINO 1.7DS/PALIO 1.7D 149B5	1986 1989 1989 1993	







OIL PUMP

EGNO. PHOTO OEM NO. APPLICATION YEAR ACCESSORIES

EG-FI118		7548014			
EG-FI119		46744429 OT061221-03			<input checked="" type="checkbox"/> Gasket 
EG-FI120		59797274 OT061221-01			
EG-FI121		1001.C6 72804801 1001.F2 3M5Q6600AC			
EG-FI122		7728249			
EG-FI123		55195304			<input checked="" type="checkbox"/> Gasket 

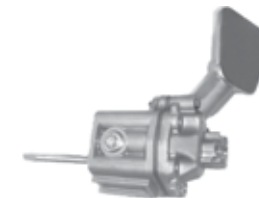
OIL PUMP

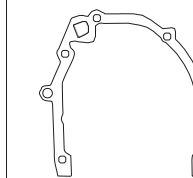
EGNO. PHOTO OEM NO. APPLICATION YEAR ACCESSORIES

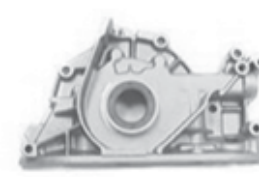
EG-FI124		7717398			<input checked="" type="checkbox"/> Gasket 
EG-FI125		46772183 46544278 7774040	BRAVA - ELX 1.6 mpi 16V BRAVA - SX 1.6 mpi 16V PALIO - 1.6 mpi 16V PALIO - ELX 1.6 mpi SIENA - ELX 1.6 mpi SIENA - STILE 1.6 mpi 16V STRADA - LX 1.6 mpi 16V STRADA - TREKKING 1.6 mpi 16V TIPO - 1.6 ie UNO - TURBO 1.4 ie WEEKEND - SPORT 1.6 mpi 16V WEEKEND - STILE 1.6 mpi 16V	99 99 96 98 98 98 98 98 88 89 97 97	<input checked="" type="checkbox"/> Gasket 
EG-FI126		46762740 55205437	SIENA 1.0 MPI FIRE 8V STRADA 1.3 MOIFIRE 8V200	2000	
EG-FI127		46738256			<input checked="" type="checkbox"/> Gasket 
EG-FI128		55232196 55185375 7177635 73502327 70419301 0646076 1538742 BS516600AA 161100N86J00 93177337 1001.G7			
EG-FI129		9015650 7728251			











OIL PUMP

EGNO. PHOTO OEM NO. APPLICATION YEAR ACCESSORIES













EG-FI130		7588T40			<input checked="" type="checkbox"/> Gasket
EG-FI131		55205437 for Brazil market			
EG-FI132		04693103AA 04777838AA 55223582	FIAT – Bravo, Dobló, Grand Siena, Idea, Línea, Novo Palio, Palio Weekend, Punto, Siena, Strada – ENGINE 1.6 / 1.8 E-TorQ 16V flex.		
EG-FI133		7533630HV	FIAT PALIO/DUNA/UNO/ FIORINO-HIVOLUME		

EGNO. PHOTO OEM NO. APPLICATION YEAR ACCESSORIES







EG-FO101		731M6600AA 1476632 6013177	Anglia 1.2 ohv 123E Capri 1.3/1.5 ohv 109E/ 116E Cortina 1.1 ohv Kent Cortina 1.3/1.6 ohv Kent Escort 1.1 ohv	59 61 61 68	
EG-FO102		712M6600AA 1490252	Capri 1.7/2.0 V4 Essex/ Capri 3.0 V6 Essex Mk II/III Consul 1.7 V4/V6/2.0 V4/V6 Consul 2.5 V4/V6/3.0 V4/V6 Granada 2.0 V4/V6/2.5 V4/V6 Granada 3.0 V4/V6 Transit 1.7 V4/V6/2.0 V4/V6 Transit 3.0 V4/V6	68 75 72 74 78 73	
EG-FO103		71HM6600AA 1438157	Cortina /Capri 1.6 ohc/2.0 ohc Granada 1.6 ohc/1.8 ohc Granada 2.0 ohc P100 Pick-Up 1.6 ohc/ 2.0 ohc Sierra 1.3 ohc/1.6 ohc Sierra 1.8 ohc/2.0 ohc Sierra Cosworth 2.0i ohc Transit 1.6 ohc/ 2.0 ohc Scorpio 2.0i ohc	70 81 82 83 85	
EG-FO104		M55HV			
EG-FO105		928M6604A2B 1663901	Orion Mk III 1.6i EFi - ZH16 Orion Mk III 1.8i EFi - ZH18 Fiesta Mk III 1.8i EFi - ZH18 Escort Mk V 1.8i EFi - ZH18 Fiesta Mk IV 1.6i EFi - Zh16	92 94	
EG-FO106		98MM6600CE 1072052	Fiesta Mk V 1.25i EFi ZH12 Fiesta Mk V 1.4i EFi ZH16 Focus 1.6i EFi ZH16 Puma 1.4i EFi ZH16	98	









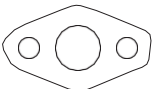

EGNO.	PHOTO	OEM NO.	APPLICATION	YEAR	ACCESSORIES
EG-FO107		E9RY6600B E6TZ6600A E7RY6600A E9RY6600A F6TZ6600AC XL2Z6600AA 1F2Z14100 2ZMZ14100 ZZL014100 ZZL014100A ZZM214100 M128	TRUCK V6 4000cc MOUNTAINEER ASROSTAR BRONCO II EXPLORER, EXPLORER SPORT TRAC RANGER	1986-2006	<input checked="" type="checkbox"/> Gasket 
EG-FO108		F8CZ6600AA 978M6600AIG 978M6600A2E 1131092 YS4Z6600AA 1076978 M317	MONDEO 2 1.6i 16V DOHC ZH16 1597CC FOCUS, MONDEO 2 1.8i 16V DOHC ZH18 1796CC COUGAR, FOCUS, MONDEO 2 2.0i 16V DOHC ZH20 1988CC	1998	
EG-FO109		F5AZ6600B M176	FORD EXPEDITION V8-5.4L FORD MUSTANG V8-4.6L LINCOLN MARK LT V8-5.4L LINCOLN NAVIGATOR V8-5.4L	08-05 08-05 07-06 08-06	
EG-FO110		77BM6600BA 6031544	Escort 1.1 HC 1.1/1.3 CFI 1.3/1.3 HC 1.3/1.3 HC SEFI 1.3 Escort Cabrio 1.1 HC 1.1/1.3 CFI 1.3/1.3 HC 1.3/1.3 HC SEFI 1.3 Escort Stufenheck 1.3 HC 1.3 Escort Turnier 1.1 HC 1.1/1.3 CFI 1.3/1.3 HC 1.3		<input checked="" type="checkbox"/> Gasket 
EG-FO111		59099	CORCEL I/BELINA I-1.3/1.4 CORCEL II/BELINA II-1.3/1.4	69/78	<input checked="" type="checkbox"/> Gasket 
EG-FO112		XS6E6600AC	KA-GL1.0I/GLIMAGE1.0I/ TECNO1.0I FIESTA-GL1.0I/GL CLASS 1.0I SPORT1.0I/GLX1.6/SPORT 1.6 ESCORT-GL1.6/SW GL 1.6 COURIER-BASE 1.6/L 1.6/XL 1.6	08-99 09-99	<input checked="" type="checkbox"/> Gasket  O-ring 

OIL PUMP

EGNO.	PHOTO	OEM NO.	APPLICATION	YEAR	ACCESSORIES
EG-FO113		XS6E6600AG	KA-GL1.0I/GL IMAGE1.0I/TECNO1.0I FIESTA-GL1.0I/GL CLASS1.0I SPORT1.0I/GLX1.6/SPORT1.6 ESCORT-GL1.6/SW GL 1.6 COURIER-BASE 1.6/L 1.6/XL 1.6 FIESTA-1.0/1.6I.0LSUPERCHANGER ECOSPORT-1.6 8V	08-99 09-99 03	<input checked="" type="checkbox"/> Gasket  <input type="checkbox"/> Pulley  <input checked="" type="checkbox"/> O-ring 
EG-FO114		029115105.6 85NU6600A 86NU6600A BD9M6600AA	Logus - CLi/ CL/ GL - 1.6 For 4 cyl. engine	92/94	<input checked="" type="checkbox"/> Gasket 
EG-FO115		85AU66001 85AU6600A 86AU6600A 029115105.5 027115105.9	FORD ESORT 1.6		<input checked="" type="checkbox"/> Gasket 
EG-FO116	 Drive Gear: 51Teeth	XM346600AC WL0114100			
EG-FO117		IS7G6600BG LF0214100			<input type="checkbox"/> Chain Gear  Chain Gear:24 Teeth
EG-FO118		91FF6600AC 1045630 1045650 1068262 91FF6600AD			
EG-FO119		DOAZ6600B M84A	V8 351 C.M. ENG.,400 ENG.,V8	2003	



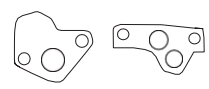





OIL PUMP

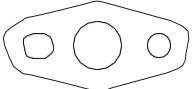

EGNO.	PHOTO	OEM NO.	APPLICATION	YEAR	ACCESSORIES
EG-FO120		M84AHV			
EG-FO121		D4FZ6600A M86C			
EG-FO122		2806270 4071040 53009295 4626055 M72			
EG-FO123		10184977 10209660 8101849770 OP328 M248	Pontiac Sunfire 2.2L L4 2190CC	1995-2002	
EG-FO124					
EG-FO125		OP4179	FORD EXPEDITION V8-5.4L FORD MUSTANG V8-4.6L LINCOLN MARK LT V8-5.4L LINCOLN NAVIGATOR V8-5.4L	08-05 08-05 07-06 08-06	
EG-FO126		06090229 9731609526	FORD MONDEO MK2 2.5 V6		

EGNO.	PHOTO	OEM NO.	APPLICATION	YEAR	ACCESSORIES
EG-FO127		XS4Q6F008AD XS4Q6F008BA 1568324 1374144 1078508	FORD FOCUS 1.8TDDIDIESELMK1 FORD TRANSIT CONNECT1.8TDDi FORD TRANSIT MONDEO 1.8TDDi	1998-2004 1998-2004 1998-2004	
EG-FO128		OP447	Ford Ranger 2.3L 2295CC I4 GAS SOHC Naturally Aspirated Mazda B2300 2.3L 2295CC I4 GAS SOHC Naturally Aspirated	1989-1994 1994	<input checked="" type="checkbox"/> Gasket 
EG-FO129		XW4Z6600DA F5RZ6600B M211	FORD 2.5L 2500cc Mercury 3.5 3500cc	1995-2000 1996-2000	
EG-FO130		OM55			<input type="checkbox"/> Pulley 
EG-FO131		L31014100A L31014100D L31014100H L31014100 L31014100E L31014100F L31014100J 3M4Z6600BA 3M4Z6600BH IS7G6600BJ M352	MAZDA3 2300CC	2002-	
EG-FO132		OP4107	Ford L6 3.9L (240), 4.9L (300), Econoline E150, E250, E350, Pick Up F-100, F-150, F-250, F-350, Club Wagon, Bronco	1965-1996	<input checked="" type="checkbox"/> Gasket 
EG-FO133					







EGNO.	PHOTO	OEM NO.	APPLICATION	YEAR	ACCESSORIES
EG-FO134					
EG-FO135		C2OZ6600A F77Z6600CA C9ZZ6600B M68	V8 221,260,289 2000CC		<input checked="" type="checkbox"/> Gasket
EG-FO136		73TM6600AA 1613225 83TM6600AA 1529339	CAPRI 2.3/2.8 V6 EURO ENGINES CORTINA 2.3 V6 GRANADA 2.3/2.8i V6 SCORPIO 2.8i V6 SIERRA 2.6/2.8i V6	1975- 1976- 1981- 1985- 1982-	
EG-FO137		9X2Q6600AB LR013487	Range Rover Sport 2.7 TDVM 4x4 2720ccm 190HP 140KW (Diesel) Discovery MK IV [2009-2016] SUV 2.7 TD 2720ccm 190HP 140KW (Diesel) JAGUAR 3.0 TDV6 60K MILES	2005-2013 2004- 2009	<input checked="" type="checkbox"/> Special-shaped Ring
EG-FO138		3764547 TMP155 M155	BOMBA ACEITE GENERAL MOTORS BLAZER 1996-1999 MELLING		
EG-FO139		PAT-19			<input checked="" type="checkbox"/> BOLT Gasket
EG-FO140	 Chain Gear:32 Teeth	TC1P6600AA ICIQ6600CE YC1Q6600CB YC1Q6600CD ICIQ6600CC ICIQ6600CD ICIQ6600CF ICIQ6600CG 1001.E9 1096225 1112956 1117948 1134856 1355193 1456884 9660667080 LR004392 LR004868 729621050	CITRO JUMPER BUS 2.2 HDI 100/120 CITROJUMPERKASTEN2.2HDI100/120 FORDRANGER2.2TDI FORD TRANSIT BUS 2.2 TDCI FORD TRANSIT BUS 2.4 TDCI FORD TRANSIT BUS 2.4 TDCI FORD TRANSIT BUS 3.2 TDCI FORD TRANSIT KASTEN 2.2 TDCI FORD TRANSIT KASTEN 2.4 TDCI FORDTRANSITPRITSCH2.2TDCI FORDTRANSITPRITSCH2.4TDCI FORD TRANSIT PRITSCH2.4 TDCI FORD TRANSIT PRITSCH2.4 TDCI FORD TRANSIT PRITSCH2.4 TDCI FORD TRANSIT PRITSCH2.4 TDCI FORD TRANSIT PRITSCH2.4 TDCI FORD TRANSIT PRITSCH2.4 TDCI FORD TRANSIT PRITSCH2.4 TDCI REUGE BOXER BUS 2.2 HDI 100/120 REUGE BOXER KASTEN 2.2 HDI 100/120 REUGE BOXER PRITSCH2.2 HDI 100/120	06 06 11 00-06 06 06 08 06 08 08 08 06 07 08 06 06 06 06	

EGNO.	PHOTO	OEM NO.	APPLICATION	YEAR	ACCESSORIES
EG-FO141		92067383			
EG-FO142					
EG-FO143		M360			<input checked="" type="checkbox"/> O-ring
EG-FO144		M513Z6600AA	Ford-Lincoln V8 4.6L (281), V10 6.8L (415), Mustang, E-350, E450, Aviator	1995-2007	
EG-FO145		ZSG-003			
EG-FO146		ZSG-002			
EG-FO147		3L3Z6600AA 9L3Z6600A M340	Expedition 5.4L 3V Explorer 4.6L 3V Explorer Sport trac 4.6L 3V F150 4.6L 3V F150 5.4L 3V F250/F350/F450/F550 5.4L 3V Mark LT 4.6L 3V Mark LT 5.4L 3V Mountaineer 4.6L 3V Mustang 4.6L 3V Navigator 5.4L 3V	2005-2010 2006-2010 2007-2010 2009-2010 2004-2010 2005-2010 2005-2010 2009-2010 2004-2010 2006-2010 2005-2010 2005-2010	

EGNO.	PHOTO	OEM NO.	APPLICATION	YEAR	ACCESSORIES
EG-FO148	 Iron Back Plate	10184977	GM L4 2.2L OHV Cavalier	1994-2003	
EG-FO149		E43Z6600A E63Z6600A M102	Ford L4 2.3L 2.5L Topaz, Tempo, Taurus	1986-1994	<input checked="" type="checkbox"/> Gasket 
EG-FO150		F7CZ6600AB FICZ6600B FOTZ6600A M179	Ford L4 1.9L(116), 2.0L (122) SOHC 8V VIN P Escort,Focus	1991-2004	
EG-FO151		D9AZ6600A C9OZ6600A M83	FORD F150/F250/ F350 5.8L V8	1969-1996	<input checked="" type="checkbox"/> Gasket 
EG-FO152	 Chain Gear:32 Teeth	BK2Q6600	FORD TRANSIT 2.2 TDCI DIESEL	2013	
EG-FO153		AL3Z6600A AL3Z6600AB	Ford F150 6.2L V8 Ford F250 6.2L V8 Ford F350 6.2L V8	2010-2014 2011- 2011-	
EG-FO154		3W4Z6600AA AJ5714100	Ford Escape XLT 3.0L V6 Ford Escape Limited 3.0L V6 Ford Fusion SE 3.0L V6 Ford Fusion SEL 3.0L V6 Lincoln Zephyr Base 3.0L V6 Mercury Mariner Premier 3.0L V6 Mercury Mariner Base 3.0L V6 Mercury Mariner Luxury 3.0L V6 Mercury Milan Base 3.0L V6 Mercury Milan Premier 3.0L V6	2011-2012 2011-2012 2008-2009 2008-2009 2006 2007-2011 2008-2011 2007 2006-2009 2006-2009	







EGNO.	PHOTO	OEM NO.	APPLICATION	YEAR	ACCESSORIES
EG-FO155		7T4Z6600AA 7T4Z6600BA ZZJ114100B M390	FORD EXPEDITION/EXPLORER/ F150/FLEX/TAURUS 3.5L V6 FORD POLICE INTERCEPTOR SEDAN BASE/MUSTANG 3.7L V6 Ford Duratec 3.5L V6 DOHC 24V	2015-2016 2015-2016 2007-2010	
EG-FO156		2F1Z6600AA 5F1Z6600AA E6DZ6600A E7DZ6600A E8DZ6600A F5DZ6600A F7DZ6600AA F8DZ6600A M129	Ford V6 3.0L(182) OHV 12 Vál. Vulcan , Aerostar, Taurus, Windstar, Sable, Topaz	1986-2007	
EG-FO157		8C3Z6600A	FORD F250/F350 SUPER DUTY 6.4L V8	2008-2010	

EGNO. PHOTO OEM NO. APPLICATION YEAR ACCESSORIES











EG-HO101		15100PB1000	ACCORD	80/81	
EG-HO102		15100PB9000	CIVIC 81, ACCORD EK BALLADE 1335 EN4 1200CC; 1300CC	73/84	
EG-HO103		15100POA000 15100PTO000 15100PTO030 15100PTO010 15100PTO020 OP219 M175	ACCORD,SE F22A6 2000CC ;2200CC	90/95	
EG-HO104		15100PAAA01 15100POAA01 5862021860 OP245 M232	PRELUDE. F22A1 ACCORD, V-TEAC C1, F22B1 ODYSSEY F22B6 OASIS 16V SOHC	96/97	
EG-HO105					
EG-HO106		15100P01003 15100PO6A01 15100PLC003			<input checked="" type="checkbox"/> Gasket 





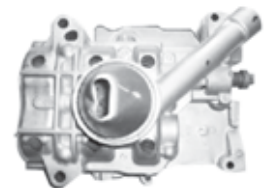

OIL PUMP

EGNO. PHOTO OEM NO. APPLICATION YEAR ACCESSORIES

EG-HO107		15100PWA003 15100RBO003 15100REAZ01	HONDA FIT 1500CC	2003	
EG-HO108		15110RAAA01	Honda Element /Acura TSX / Honda Accord 2.4L 2354CC I4 GAS DOHC Naturally Aspirated	2003-2009	
EG-HO109		15110RACA01			
EG-HO110		15100RIPU01 15100RZP003	FA1 本田思域		
EG-HO111		OPH48			
EG-HO112		OPH46L			











OIL PUMP





EGNO.	PHOTO	OEM NO.	APPLICATION	YEAR	ACCESSORIES
EG-HO113		15110R40A01	Acura TSX 2.4L 2354CC L4 GAS DOHC Naturally Aspirated Honda Accord 2.4L 2354CC 144Cu. In. I4 GAS DOHC Naturally Aspirated Honda Accord 2.4L 2354CC I4 GAS DOHC Naturally Aspirated	2009-2010 2008-2009 2008-2009	
EG-HO114		516100			
EG-HO115		15100PR3024 15100PR4A03 15100PR4000 15100PR3014 15100PR4A01 OP212	Acura Integra 1.8L 1797CC I4 GAS DOHC Naturally Aspirated	90-95	<input checked="" type="checkbox"/> GASKE  O-RING 
EG-HO116		15100OA040 OP963			<input checked="" type="checkbox"/> GASKE  O-RING 
EG-HO117		151005R0003	Honda EX-LN (LEATHER/NAVI) 6 Speed Manual Honda EX Variable Honda EX 6 Speed Manual Honda EX-L (LEATHER) 6 Speed Manual Honda LX 6 Speed Manual Honda EX-LN (LEATHER/NAVI) Variable Honda LX Variable Honda EX-L (LEATHER) Variable Honda DX 6 Speed Manual	2015- 2015- 2015- 2015- 2015- 2015- 2015- 2015- 2015-	
EG-HO118		1500RZA013	Honda L4 2.4L (2354cc) DOHC 16 Vál. , CR-V (kit de Repuesto)	2007-2009	
EG-HO119		13400RZP000	RE2/CP1/RE1		

EGNO.	PHOTO	OEM NO.	APPLICATION	YEAR	ACCESSORIES
EG-HY101		2131002500	ATOS SANTRO 800CC		
EG-HY102		2131023002 2131023001 M272	HYUNDAI ELANTRA L4 2.0L HYUNDAI ELANTRA L4 1.8L HYUNDAI TIBURON L4 2.0L HYUNDAI TIBURON L4 1.8L HYUNDAI TUCSON L4 2.0L KIA SPECTRA L4 2.0L KIA SPECTRA L4 2.0L KIA SPECTRA5 L4 2.0L KIA SPORTAGE L4 2.0L	09-99 98-96 08-97 1997 07-05 07-04 07-05 07-05 07-04	
EG-HY103		2131035002 2131036010 2131035070 MD154258 M332	SONATA 2797CC; V6 12V DOHC;G6AT MITSUBISHI MONTERO PICKUP 12 VALVE	1999	
EG-HY104		2134042501	4D55/56/D4BA		
EG-HY105		2134042800 MD181581-2	4D55/56T/D4BA	95/98	
EG-HY106		2131021030 2131021010 2131021020 M170	EXCEL SCOUPE G4DJ 1468CC SCOUPE G4AE 1495CC SCOUPE TURBO G4AE 1495CC	90/94 93/95 93/95	

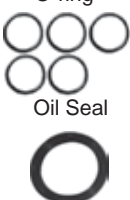
EGNO.	PHOTO	OEM NO.	APPLICATION	YEAR	ACCESSORIES
EG-HY107		2131022010 2131022011 2131022650 2131022020	ACCENT G4AE 1500CC G4EB 1500CC	95/99 00/02	
EG-HY108		2131026800	HYUNDAI ACCENT L4-1.6L HYUNDAI ACCENT L4-1.5L	05-01 96-97	
EG-HY109		2131002552	HYUNDAI G4HG 1000CC	2003- 2005	
EG-HY110		2131032088			<input checked="" type="checkbox"/> Gasket Washer O-ring
EG-HY111		2134042106			

EGNO.	PHOTO	OEM NO.	APPLICATION	YEAR	ACCESSORIES
EG-IS101		8970331733	4JAT1(LATE)		
EG-IS102	 Rotor Thickness:18mm	8944273030 8944273031 8944656650	4ZD1,4ZC1 TROOPER L-2300 2300CC ROTOR DEPTH 0.707	85/95	
EG-IS103		8973859820			
EG-IS104		8971038640 8943745104 M220	6VD1 DOHC	92/97	
EG-IS105		8970697381	PANTHER KBD-23LE KB28,4JB1 2500CC	87/88	
EG-IS106		83500826 83501486 10087696 10146802 14033065 14033227 14085460 8100876960 8101468020 8140854600 M95B	Buick Regal/Chevrolet/ Oldsmobile/Pontiac 3.1L 189 Cu. In. V6 GAS OHV Naturally Aspirated Chevrolet/GMC/Oldsmobile/ Pontiac 2.8L 173Cu. In. V6 GAS OHV Naturally Aspirated	1990 1988-1990	
EG-IS107		8943355870	4BD1/4JA1		







EGNO.	PHOTO	OEM NO.	APPLICATION	YEAR	ACCESSORIES
EG-IS108	 Rotor Thickness:20mm	8944597301 8944597300 M173	Isuzu Rodeo/Isuzu Amigo/Isuzu Pickup/Isuzu Trooper 2.6L 2559CC I4 GAS SOHC Naturally Aspirated Honda Passport 2.6L 2559CC I4 GAS SOHC Naturally Aspirated	1988-1997 1994-1996	<input checked="" type="checkbox"/> Plastic Cover Special-shaped Ring 
EG-IS109	 Rotor Thickness:18mm				<input checked="" type="checkbox"/> Plastic Cover Special-shaped Ring 
EG-IS110					
EG-IS111		8971364630			<input checked="" type="checkbox"/> O-ring 
EG-IS112		M155HV			<input checked="" type="checkbox"/> Gasket 
EG-IS113	 Drive Gear:29Teeth				
EG-IS114		8971038640 8943745104	ISUZU TROOPER/RODEO 3.2L 3165CC V6 GAS SOHC Naturally Aspirated HONDA PASSPORT 3.2L 3165CC V6 GAS SOHC Naturally Aspirated ACURA SLX 3.2L 3165CC V6 GAS SOHC Naturally Aspirated	1994-1997 1994-1997 1996-1997	<input checked="" type="checkbox"/> O-ring Oil Seal 

EGNO.	PHOTO	OEM NO.	APPLICATION	YEAR	ACCESSORIES
EG-KI101	 Iron Back Plate	OK93314100	KIA SEPHIA L4-1.6L	95-94	
EG-KI102		2131002500	ATOS SANTRO 800CC		
EG-KI103		E9GZ6600A E9GZ6675A E9JY6600A B63014100B B63014100C B63014100D B63014100E B63014100F BP0114100 M141	FORD FESTIVA L4-1.3L MAZDA 323 L4-1.6L MERCURY TRACER L4-1.6L	92-88 90-86 89-87	<input checked="" type="checkbox"/> Gasket 

EGNO.	PHOTO	OEM NO.	APPLICATION	YEAR	ACCESSORIES
EG-LA101		21211011010	NIVA 1600 4WD 1.2-1.6	1979	
EG-LA102		21011011010	131-1.3/1.4/1.6-131 A/C2 131 MIRAFIORI 1.3-1.6 131A/1 131 SUPER MIRAFIORI 1.3/1.4/1.6 B/C 132 1.6/2.0 132D-B2 ARGENTA1.6-2.0-132D 124 SPORT 242 PICK-UP1.6 242/15VAN 124B3	1972 1975 1978 1972 1981 1973	
EG-LA103		2101102077			
EG-LA104		21081011205 2101102077B			
EG-LA105		46794812			
EG-LA106		4061011010			

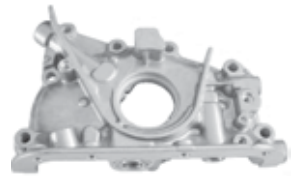

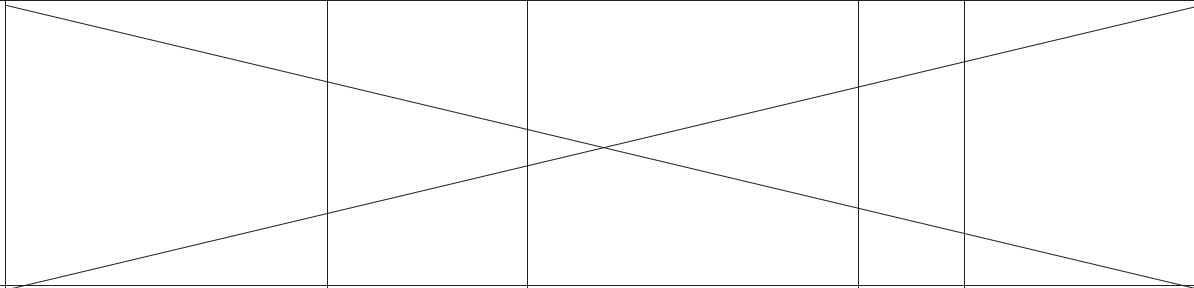



EGNO.	PHOTO	OEM NO.	APPLICATION	YEAR	ACCESSORIES
EG-LR101					
EG-LR102					
EG-LR103					
EG-FO137		9X2Q6600AB LR013487	Range Rover Sport 2.7 TDVM 4x4 2720ccm 190HP 140KW (Diesel) Discovery MK IV [2009-2016] SUV 2.7 TD 2720ccm 190HP 140KW (Diesel) JAGUAR 3.0 TDV6 60K MILES	2005-2013 2004- 2009	<input checked="" type="checkbox"/> Special-shaped Ring
EG-O70		LPF000030	MG ROVER K SERIES ENGINE TO FIT MGF/TF, ZR, ZS, ZT AND ROVER 25,45 AND 75 ALSO FIT LAND ROVER FREELANDER Fit all K Series engine cars - 1.1, 1.4, 1.6, 1.8 and VVC		

EGNO. PHOTO OEM NO. APPLICATION YEAR ACCESSORIES









EG-MA101		817314100 376314100 045314100 M163	MAZDA 626 L4-2.0L MAZDA B2000 L4-2.0L	82-79 84-79	
EG-MA102	 Drive Gear:38 Teeth	SL7014100B			
EG-MA103		FS0114100N F72Z6600AA M192	FORD PROBE L4-2.0L MAZDA 626 L4-2.0L MAZDA MX-6 L4-2.0L	97-93 97-93 97-93	
EG-MA104		F80114100D F80114100E F80114100F F80114100G FE3014100A FE3014100B FE3014100C FE6514100 FE6514100C FE6514100D FE6514100E FE6514100F M140	323SL F6, 323 SLE EGL, SLIFE 626S, SL, SLX F6, 626 SLE F8 626 EGL, SLIFE	83/89	
EG-MA105					
EG-MA106		F20114100AC F20114100A	MAZDA 323 SLE 1998cc MAZDA 626 200SL,SLE 1998cc MAZDA 323 200E,MIDGE 1988cc 200E,6G03,FE,FE88 1597cc	1989-1991 1989-1992 1991- 1995-1997	

OIL PUMP







EGNO. PHOTO OEM NO. APPLICATION YEAR ACCESSORIES

EG-MA107		F21214100E F21214100C F21214100D F12Z6600BA E92Z6600A F12Z6600A M151	PROBE 2.5i V6 24V DOHC 2497CC 626 MX6 XEDOS 2.5 V6 24V DOHC 2497CC; 626,629 MX6 TURBO 2.0,B2200 PICKUP 2.0	92-95 1993 88-92	<input checked="" type="checkbox"/> O-RING 
EG-MA108	 Chain Gear:29 Teeth	E58014100A E58014010 E58014010A E30114100A	E3/E5		
EG-MA109		ZL0114100	MAZDA 323 1600CC		
EG-MA110			MAZDA 479Q		<input checked="" type="checkbox"/> O-RING 





OIL PUMP

EGNO.	PHOTO	OEM NO.	APPLICATION	YEAR	ACCESSORIES
EG-ME101		6161800101 6161800201 6161800401 616000005	T1 (601) 207 D 2.4 W 115 240 D (115.117) T2/LN1 507 T2/L 407 Unimog 52, 600, 60T, 650 G-Class (W 460) 240 GD(460,3)	97/96 68/77 86/94 68/88 66/71 79-93	
EG-ME102	 Chain Gear:24 Teeth	1111800801 6041810520 1111800201 1111800301 6011800101	W201,W202, S202, C208, A208, W124,C124, S124, W210, S210, A124, S210		<input checked="" type="checkbox"/> O-ring 
EG-ME103	 Chain Gear:24 Teeth	6011801401 1121810020	311CDI / 313CDI / 411CDI / 413CDI / OM611LA		
EG-ME104	 Chain Gear:24 Teeth	6011810220 6111800101	W210 /W211/ W220/ W221/ ML350/R350		<input checked="" type="checkbox"/> O-ring 
EG-ME105	 Chain Gear:24 Teeth	6061810801 6111800001			<input checked="" type="checkbox"/> O-ring 
EG-ME106		3761807301 3441800201	Sohneider Vibro Sperry Rand do Brasil Case W = 20 B Tema Terra C.N.G. Betova Komatsu D-30 / D-50 Hoos Maquinas Engesa Retipar P.P.M. ASBrasil Dynapac Alvenius Dresser Ederer & Cia Companhia Brasileira de Tratores Sulbra-Sul Fiat Allis Clark 45C/55-A Muller TC 15 -B Malves Santa Matilde Vaselli De Antonini Huber Warco 130 M Galion		

OIL PUMP









EGNO.	PHOTO	OEM NO.	APPLICATION	YEAR	ACCESSORIES
EG-ME107		3521804801 3431800101	FOR OM 314/352/352-A 6CIL		
EG-ME108	 Drive Gear:44 Teeth	4231800501 4231802501 403L801701	OM403,423A,423A/ LA BM900/1/5/8 OM424A/LA	1989	
EG-ME109	 Rotor Thickness 25mm	6021800101 6021802801	190D 2.5D 602.911/12/61/62 300D/TD 3.0DT/D OM603.912/3	1986 1985	
EG-ME110	 Rotor Thickness 30mm	6031800001 6031802801	KOMBI(S124) 300 TD(124,190) STUFENHECK(W124) 300D(124)	01.89/ 06.93	
EG-ME111	 Rotor Thickness 30mm	6031801201 1041800701 1041800201	C-CLASS(W202) COUPE(C124) E-CLASS(W124),(W120) A124,(C124),(S124) KOMBI(S124) SL(R129) STUFENHECK(W124) 280,300,320	05.93/05.00 09.89/05.93 06.93/06.96 10.92/06.93 08.93/10.01 10.92/06.93	
EG-ME112	 Rotor Thickness 27mm Chain Gear:24 Teeth	6021803001	210D-310D-410D SPRINTER-512D-612D- 614D-812D 5CYL DIESEL 212D-312D-412D VITO	1994 1996	

OIL PUMP

EGNO.	PHOTO	OEM NO.	APPLICATION	YEAR	ACCESSORIES
EG-ME113		1151801301	200 2.0 M115 200D 2.0 OM615 220 2.2 M115-220D-OM615 230 2.3 M115 0309B 2.2 M115 207D/208D/307D/308D 2.2 OM615 L206D/306D/-2.0 BM309-BM115-BM606 BM607-BBM608	1972 1972 1972 1972 1972 1971	
EG-ME114		A9061800801 9061800801 9061800601 9061800201	OM904LA		
EG-ME115		M-8192			
EG-ME116	 Chain Gear:20 Teeth	6461801601	OM646.983/OM646.985/ OM646.986/OM646.989	2002-2010	<input checked="" type="checkbox"/> O-ring 







EGNO.	PHOTO	OEM NO.	APPLICATION	YEAR	ACCESSORIES
EG-M101		MD009044 MD009047	L-300 L-031P COLT 4G32	1980	
EG-M102		MD014603 2610041000	4D31 PS100, FE-119 4D31 FE304, FE334, FE347 FE349	1983	
EG-M103		MD025550	4G52,4G54 V32	1985	
EG-M104		MD187896 MD193384 MD327450 MD193384 MD327450 MD327450.0 M198	V31 4G63,4G63K,4G64FR 4G64,CHRYSLER,EAGLE PLYMOUTH 2000CC. 2400CC.	93/98	
EG-M105		MD346529.2 MD194007	4G63K, L200 DELICA(DE 2.0)		
EG-M106		MD181579 MD181579X..9	DET2.5 2500CC		

EGNO. PHOTO OEM NO. APPLICATION YEAR ACCESSORIES

EG-M107		ME014777	PS-100 PE-111		
EG-M108		MD181581..2 MD181581X..AO	DE2.5 2500CC		
EG-M109		MD175762 MD129347 2131033142	4G61,4G63,DOHC ECLIPSE EAGLE TALON PLYMOUTH LASER HYUNDIC SONATA G4CR 1600CC 2000CC	89/92 90/92 92/97	<input checked="" type="checkbox"/> Gasket  Washer O-ring
EG-M110		MD103718 MD133667 MD152909 MD304293 M142	CHRYSLER, MITSUBISHI 12 VALVE,SOHC,V6;F.INJ; 6G72 FWD;2972CC CARAVAN/VOYAGER;DYNASTY/ DAYTONA;LEBARON/SPIRIT; SHADOW/SUNDANCE; ACCLAIM/NEW YORKER	88/00	<input checked="" type="checkbox"/> Gasket 
EG-M111		MD154251 M324	6G75 3000CC	89/94	
EG-M112		MD346380 M344	CHRYSLER SEBRING V6 3.0L DODGE STRATUS V6 3.0L MITSUBISHI ECLIPSE V6 3.0L GALANT V6 3.0L	05-01 05-01 05-00 03-99	<input checked="" type="checkbox"/> Gasket 

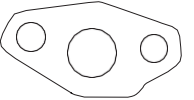







OIL PUMP

EGNO. PHOTO OEM NO. APPLICATION YEAR ACCESSORIES







EG-M113		MD021530 MD022550 MD022560 MD022564 MD060517 AM1514100 M122	CELESTE,GALANT,COLT 2.0 8V SOHC 4G52 1995CC SIGMA,MONTERO 2.0 8V SOHC 4G52B 1995CC GALANT,SAPPORO 2.6 8V SOHC 4G52 2555CC PAJARO PICK UP,SHOGUN 2.6 8V SOHC 4G54/B 2555CC	1975 1977 83-90 83-91	
EG-M114		MD134566	CM66 4D82 1100CC	88/96	
EG-M115		MD110232 MD110233 M199	ECLIPSE SOHC 4G37 F.I.SOHC,4,CHRYSLER EAGLE PLYMOUTH 1755CC	89/94	<input checked="" type="checkbox"/> Gasket 
EG-M116		MD782504	4G37	89/94	
EG-M117		MD332352	MIRAGE L4 1.5L	02-97	
EG-M118		ME014600 2610041400	4D34		

OIL PUMP



EGNO. PHOTO OEM NO. APPLICATION YEAR ACCESSORIES

EG-M119		MD363751 1211A021	V73 MONTERO SPORT 6G72 3.8L	1995- 2001	
EG-M120	 Drive Gear:37 Teeth	ME204053 ME201735 MB08026	PAJERO V26/46 4M40		
EG-M121		MD184886 MD308625 MB08075 M331	V43 MONTERO SPORT 4G72/6G72 3.0L	1995- 2001	<input checked="" type="checkbox"/> Gasket  O-ring 
EG-M122		MD304293 MD152909			
EG-M123		MB993323			
EG-M124		1211A033 1211A142	CW6W/6B31		

EGNO. PHOTO OEM NO. APPLICATION YEAR ACCESSORIES





EG-M125		1211A039	4B10,4B11, GF7W,CW4W, GA2A		
EG-M126		1010100GA	4GA1		
EG-M127		MD335602	A350		
EG-M128			长安面包车		<input checked="" type="checkbox"/> O-ring 
EG-M129		PW891228N	PROTON EXORA , EXORA BOLD PROTON GEN 2 PROTON PERSONA PROTON PREVE PROTON SAGA BLM , SAGA FL , SAGA FLX PROTON SATRIA NEO PROTON SUPRIMA PROTON WAJA CAMPRO , WAJA CPS	2009-2013 2004-2007 2007-2014 2012- 2008-2011 2006-2013 2013- 2006-2011	
EG-M130			4A91		

EGNO. PHOTO OEM NO. APPLICATION YEAR ACCESSORIES

EGNO.	PHOTO	OEM NO.	APPLICATION	YEAR	ACCESSORIES
EG-M131		MN1060A080			
EG-M132		1010200GC	Oil filter bracket component		
EG-M133		1010200GA	Oil filter bracket component		









OIL PUMP

EGNO. PHOTO OEM NO. APPLICATION YEAR ACCESSORIES

EGNO.	PHOTO	OEM NO.	APPLICATION	YEAR	ACCESSORIES
EG-MW101	 Drive Gear:30 Teeth	2RA115105 922907300096 632507300076	D-225-3/D-225-4/D-225-6/D-226-4/ D-229-3/D-229-4/D-229-6 Veicular/Estacionaria/ Industrial/Gerador/Maritimo /Agricola		<input checked="" type="checkbox"/> O-RING 
EG-MW102	 Drive Gear:26 Teeth	961007300016 961007300046 961007300056 961087300016	VOLARE A8 6460 / A8 7310 MWM 410 / 410T / 410TCA / 610 / 610T / 610TCA		
EG-MW103	 Drive Gear:30 Teeth	632507300200			









OIL PUMP

EGNO. PHOTO OEM NO. APPLICATION YEAR ACCESSORIES

EG-NI101		15010H6200 15010H9700 15010H9701 15010M3000 15010M3001 M90A	A12,12A,13,14,15 B110,B220 1300CC ; 1500CC	70/82	
EG-NI102		1501021001 M90	L-16,18,20B224,24E Z20,20E,20S,Z22,22E Z24,24L,L26,26E,28ET 2000CC	69/89	<input checked="" type="checkbox"/> Gasket 
EG-NI103		1501017M00 15010B03G1 1501001M00 M114	E13,15S,E16,EA16I 1500CC 1600CC	82/88	<input checked="" type="checkbox"/> Gasket 
EG-NI104		1501010V01 15010V5002	300ZX,200SX,MAXIMA VG30E,VG301 3000CC	87/89	
EG-NI105		1501016A01 1501059Y00	B11,B12,B13	84/93	
EG-NI106		1501017F00 1501017F01 15010D0103 15010D0104 15010D3500 15010D3501 M113	PULSAR,PRARISE,SILVIA, STANZA 1.8 8V SOHC CA18 1809CC; PULSAR,PRARISE,SILVIA, STANZA 2.0 8V SOHC CA20 1993CC	1984	

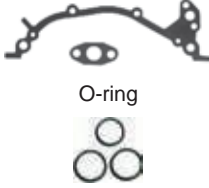
OIL PUMP

EGNO. PHOTO OEM NO. APPLICATION YEAR ACCESSORIES

EG-NI107		150101W900 150100W001 M237	PATHFINDER R50 VG33E 3300CC	96/97	<input checked="" type="checkbox"/> Gasket 
EG-NI108		15010V0300 M111	Z24, 4CYL L28E, ET, LCYL SOHC (1.570 STD PRESSURE) 2400CC,2800CC	75/89	<input checked="" type="checkbox"/> Gasket 
EG-NI109		1501012G00 1501012G01	VG30E PICK UP INFINITI V-6 2960CC	84/95 84/96	<input checked="" type="checkbox"/> Gasket  O-ring
EG-NI110		1501043G04 1501043G05	TD23 TD25 2.5L TD27 2.7L TD25I 2.5L	1995-1999 1990-1996 1988-1999	
EG-NI111		1501043U00 1501043U01 1501043U03	INFINITI FX35 V6-3.5L INFINITI G35 V6-3.5L INFINITI I35 V6-3.5L INFINITI M35 V6-3.5L INFINITI QX4 V6-3.5L NISSAN 350Z V6-3.5L NISSAN ALTIMA V6-3.5L NISSAN MAXIMA V6-3.5L NISSAN MURANO V6-3.5L NISSAN PATHFINDER V6-3.5L NISSAN QUEST V6-3.5L NISSAN QUEST V6-3.5L	07-03 04-03 04-02 07-06 03-01 05-03 05-02 05-02 05-03 04-01 05-04	
EG-NI112		1350110W02	720 D21 2.4L Z24	1983-1989	

OIL PUMP

EGNO. PHOTO OEM NO. APPLICATION YEAR ACCESSORIES

EG-NI113		2132103J01	NISSAN PATROL 3000CC P55, P60 OIL COOLER COVER	1988-1997	
EG-NI114		15010EM30B M393	Versa 1.8L 1798CC I4 GAS DOHC Naturally Aspirated TIIDA 1.8 DOHC MR18DE	2007-2011 2007-2009	
EG-NI115		135003S500 1350053Y00 1350053Y01 1350053Y02 1350070Y00 1350077A00	SENTRA NX GA16DE 1597CC SENTRA 200SX GA16DE 1597CC B13,331,341	1991-1994 1995-1999	
EG-NI116					
EG-NI117		150103AA0A			
EG-NI118		1500024W00 15000B3000 15000B52G1 15000B52G7 15000U3200	DATSUN 720 1500cc DTASUM 620 J15,J16,J18	1970-	

OIL PUMP

EGNO. PHOTO OEM NO. APPLICATION YEAR ACCESSORIES

EG-NI118A		15000J12G1	Nissan-Datsun L4 1.6L (1567cc) J16, 1.8L (1751cc) J18 1965-94, 510, 620 Pick Up, 520 Pick Up, 521 Pick Up, Ichi Van, Sakura (Cuello Largo)		
EG-NI119			NISSAN HITACHI RENAULT		
EG-NI120		12410MA00C	Nissan Urvan 2.5L QR25DE Nissan NV350 2.5L QR25DE	2008-2012 2013-2014	
EG-NI121		150103RC0B			
EG-NI122		135008J002 135006N203 135006N20B 135006N20C 135008J00B 15010ED80C	Nissan Sentra, 2.5L 2499CC 152Cu. In. L4 C-TRAIL QR25DE	2002-2006	
EG-NI123		15010EA20A 15010EA200	Nissan Frontier 4.0L V6 Nissan NV1500/NV2500/ NV3500 4.0L V6 Nissan Xterra 4.0L V6 Frontier VQ40DE	2012-2016 2012-2015 2013-2015 2004-	<input checked="" type="checkbox"/> O-RING

OIL PUMP

EGNO. PHOTO OEM NO. APPLICATION YEAR ACCESSORIES

EG-NI124		135005M00A 135005M000	Nissan Sentra 1.8L 1809CC L4	2000-2006	<input checked="" type="checkbox"/> Special-shaped Ring
EG-NI125		150107S00A 150107S000	Nissan NV2500/NV3500 5.6L 5552CC V8 Nissan Pathfinder 5.6L 5552CC V8 Infiniti QX56 5.6L 5552CC V8 Nissan Armada VK56DE	2012 2004-2012 2004-2008 2003-	<input checked="" type="checkbox"/> Check Valve Assembly <input checked="" type="checkbox"/> Rubber Steel Bush Assembly O-ring
EG-NI126		135003TA1C 135003TA0B 135003TA0C	Nissan Altima 2.5L L4 Nissan Pathfinder 2.5L L4 Nissan Rogue 2.5L L4	2013-2015 2014 2014-2016	<input checked="" type="checkbox"/> Special-shaped Ring O-ring
EG-NI127		13500ET80A 13500ET80B 13500ET80C	Nissan Rogue 2.5L L4 Nissan Rogue Select 2.5L L4 Nissan Sentra 2.5L L4 QR25DE	2008-2013 2014-2015 2007-2012 2007-	<input checked="" type="checkbox"/> Rubber Steel Bush Assembly O-ring

OIL PUMP

EGNO. PHOTO OEM NO. APPLICATION YEAR ACCESSORIES

EG-OP101		93440777 90570919 93244703 90412744 96285525	Astra 1.6i C16SE, C16NZ Vectra 1.6i 16SV, C16NZ Vectra 1.4i 14NV Tigra 1.6i X16XEL, 16v Tigra 1.4i X14XE, 16v Kadett E 1.6i E16SE, C16LZ	91 88/92 88/92 93 93 88/92	<input type="checkbox"/> Gasket
EG-OP102		90400091	OPEL CORSA WIND DAEWOO G15MF	88/93	
EG-OP103		94610563	Chevette - Junior/ L/ SL/ SL/ E/ DL/ SE 1.0/ 1.4/ 1.6/ SLE Marajo - SL/SLE/SE -1.4/ 1.6 DL Chevy 500 - SL/ DL/ SE - 1.4/ 1.6 S/R SLE	73/93 81/90 84/95	
EG-OP104		0646030 0646032 90325074 90295214 90233175	Calibra 2.0i c 20 NE; Ascona c 1.6 16 SH Ascona c 1.8 E 18 NV Ascona c 2.0 i 20 SHE Astra F 1.8i c 18 NZ, Astra F 2.8i c 20 NZ Kadett E 1.8 ,E 2.0;Omega A 1.8,2.0;Vectra A 1.8,A 2.0	90-97 81-86 87-88 87-88 91-98 91-98 84-95	<input checked="" type="checkbox"/> Gasket
EG-OP105		0646042 0646001 90442362 90541506 90295217	Astra 1.8i 18SE,C18NZ, C18SEL,C18XE, C18XEL Ecotec Astra 2.0i C20NZ,C20XEL cotec Vecra B 1.6 16v,X16XE,X16XEL Vecra B 1.8 16v,C18XE/XEL, X18XE Ecotec	93-95	<input checked="" type="checkbox"/> Gasket
EG-OP106		0646028 90234700 90231884 90411590	Ascona C 1,6 DA 1,6 Astra F 1,7 D 1,7 Kadett E 1,6 DA 1,6 Kadett E 1,7 D 1,7 Vectra A 1,7 D 1,7	87-89	<input checked="" type="checkbox"/> Gasket

OIL PUMP

EGNO. PHOTO OEM NO. APPLICATION YEAR ACCESSORIES











EG-OP107		24406585 90570980 09129092 93287137 0646067	PARA MOTORES VECTRA 2.0 16V VECTRA 2.2 16V ASTRA 2.0 16V ZAFIRA 2.0 16V	99	<input checked="" type="checkbox"/> Gasket Special-shaped Ring
EG-OP108		90570925 90499157	Bomba para motors ohc 2000 Vectra astra pickup s10 Omega 2.2 suprema 2.2 Blazer 2.2 Kaddet Ipanema gl/gls 2.0	93	<input checked="" type="checkbox"/> Gasket O-ring
EG-OP109		0646026 0646023 94651307 90169113	MONZA BOMBA PARA MOTOR OHC 1600/1800CC	82/85	<input checked="" type="checkbox"/> Gasket O-ring
EG-OP110		93293030	GM L4 1.4L (85), 1.6L (96) SOHC 8 Vál. 1994-12, Chevy, C2, Pop, Swing, Monza, Pick Up, Station Wagon		<input checked="" type="checkbox"/> Gasket
EG-OP111		14091485 93258835 03832449 M62	GM OMEGA/BLAZER/SILVERADO SUPREMA/OPALA/CARAVAN 4.8L L6	68/92 71/92 75/92 85/96 81/84	
EG-OP112		93294869	CORSA SEDAN/CORSA HATCH-1.8 MPFI 8V CORSA SEDAN/CORSA HATCH-1.7 DIESEL MERIVA-1.8 MPFI 8V	02	<input checked="" type="checkbox"/> Gasket

EGNO. PHOTO OEM NO. APPLICATION YEAR ACCESSORIES

EG-OP113		90570921 90411568	GM VECTRA/OMEGA/ASTRA 2.0/2.2	94/96 95/96 93/98 95/00 97/98	<input checked="" type="checkbox"/> Gasket O-ring
EG-OP114		90448054	GM VECTRA GSI 2.0 16V	94/96 93	<input checked="" type="checkbox"/> Gasket O-ring
EG-OP115		94657310			<input checked="" type="checkbox"/> Gasket O-ring
EG-OP116		5204			
EG-OP117		5205			
EG-OP118		84133090			







EGNO.	PHOTO	OEM NO.	APPLICATION	YEAR	ACCESSORIES
EG-OP119		0646041 90444316 90442241 90369451 0646132 0646009 0646133			<input checked="" type="checkbox"/> Gasket
EG-OP120		0646126 91056971			<input type="checkbox"/> Gasket
EG-OP121		90570929			<input checked="" type="checkbox"/> Gasket
EG-OP122		90536036			<input type="checkbox"/> Iron Gasket
EG-OP123		0646046 92067276			<input type="checkbox"/> Gasket
EG-OP124		0646048			<input checked="" type="checkbox"/> Gasket

EGNO.	PHOTO	OEM NO.	APPLICATION	YEAR	ACCESSORIES
EG-OP125		0646029			
EG-OP126		0609229 0646057			<input checked="" type="checkbox"/> Gasket
EG-OP127	 Rotor Housing Depth:4 mm Without rotor and could be assembled with EG-OP128	0646012 0646014	CORSA 1.5D TD 4EC1 NAV1 CORSA 1.7D TD 4EE1 NOVA 1.5D TD 4EC1 NAV1 ISUZU ENGINE DIESEL	1993 1994 1992	<input type="checkbox"/> Special-Shaped Ring
EG-OP127A	 Rotor Housing Depth:2 mm Without rotor and could be assembled with EG-OP130				<input type="checkbox"/> Special-Shaped Ring
EG-OP128	 Rotor Thickness 25mm				
EG-OP129	 EG-OP127 + EG-OP128 + PULLEY	0646164	Opel 1.7D		<input type="checkbox"/> Special-Shaped Ring
EG-OP130	 Rotor Thickness 23mm				

EGNO.	PHOTO	OEM NO.	APPLICATION	YEAR	ACCESSORIES
EG-OP131		90411568	GM Astra 2.0 8V GM Astra 1.8 8V GM Blazer 2.4 MPFI GM Blazer 2.2 EFI	1995-2012 1999-2002 2001-2011 1996-1999	<input type="checkbox"/> Gasket 
EG-OP132		MBO0340	GM 2.4 MPFI 4CYL		<input type="checkbox"/> Gasket 
EG-OP133		93330219	FIAT Dobló 1.8 16V GM Meriva 1.8 16V FIAT Stilo 1.8 16V	2002-2010 2005-2007 2003-2007	<input checked="" type="checkbox"/> Iron Gasket 
EG-OP134		93377141 93313799	GM Corsa Novo 1.8 8V FIAT Dobló 1.8 8V FIAT Idea 1.8 8V GM Meriva 1.8 8V	2005-2012 2002-2010 2006-2010 2005-2012	<input checked="" type="checkbox"/> Iron Gasket 
EG-OP135		24578508	GM – Onix, Prisma 1.0/1.4 4cil. SPE/4 / Cobalt, Spin, Montana, Agile Econoflex 1.0/1.4 4cil.	2012-2015	
EG-OP136		55566000	Astra J A20DTH, Y20DTJ, Z20DTJ, A20DTR 1956cc Cascada A20DTH, A20DTR 1956cc Insignia A20DT, A20DTC, A20DTE, A20DTH, A20DTJ, A20DTL, A20DTR 1956cc Zafira C A20DTL, Y20DTJ, Z20DTJ, A20DT, A20DTH 1956cc	2010- 2013- 2009- 2012-	<input checked="" type="checkbox"/> Iron Gasket 



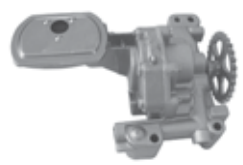
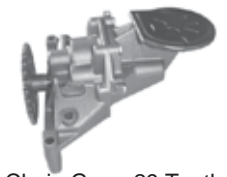

EGNO.	PHOTO	OEM NO.	APPLICATION	YEAR	ACCESSORIES
EG-PE101		1001.30 1001.40	Citroen AX TUD3 1,4 TU1 1,1 TU1M 1,1 TU1MCZ 1,1 TU3 1,4 TU3F 1,4 TU3FM 1,4 TU3FJ2 1,4 TU3G 1,4 TU3JP 1,4 TU3J2 1,4 TU3M 1,4	1971 1966 1980	
EG-PE102		1001.29	404 1.6 XC5, XC7 404 1.8 XC Pick-up/1.8 D XC Pick-up Diesel 504 1.6 XC5	71/80 70 67/70	
EG-PE103		1001.32 7941103390	J9 2.3D XD2/XD2P/XD94; 504 2.3D XD2P/XD94; J7 2.3DXD2P/XD94; 505 2.3D XD2/XD2P/XD94 404 DIESEL 2.0D XD88/XDP88 505 2.3TD XD2S;604 2.3TD XD2S/XD25/XD3 404 DIESEL 2.0D XD88/XDP88 505 2.5D XD3	76 79/85 71-79 68	
EG-PE104	 Chain Gear :29 Teeth	1001.56 95624091 7941103100 9431292021 96012074	Boxer 1.9 D XU9D 305 1.6 XUD7/9, XU95, XU9J1 205 1.6 XU5/1C,XUD79 1.9i XU5/1C,XUD79 1.8 XU5/1C, XUD79,305 1.8 XUD7/9,XU95, XU9J1 1.9 XUD7/9,XU95, 205 1.8 XU9,XUD9 1.9 XU9, 309 1.8 XUD9 1.9 D XUD9 306 1.6 XUD7/9 1.6i XU51C,XU5M,XUD9/9 1.8 XU51C,XU5M,XUD9/9 1.9 XU51C,XU5M,XUD9/9	94 82 83 86 86/93 82/95 89	
EG-PE105		1001.37	504 2.0 D XD88, XD2/3 504 2.3 D Pick-up XD2, XD94 504 2.3D/2.5D XD88, XD2/3 505 2.3D/2.3TD XD2/25, XD3 505 2.5 D XD2/25, XD3 604 2.3D/2.5TD XD25, XD3 Boxer 1.9 D XU9D	68 76 68 79 79 80/ 87 94	
EG-PE106	 Chain Gear :29Teeth	1001.50 9431102021	106 1.0 TU9-TU1-K-TUIM/1.1 TU9 TU1-K-TUIM/1.4i ,TU3M 205 1.0 TU9/1.1 TU1/1.4 TU3 306 1.1 TU1/1.4 TU3-F2 309 1.1 TU1/1.4 TU3-F2/1.6i XU5,XU5J	91 87/94 93 88	

EGNO. PHOTO OEM NO. APPLICATION YEAR ACCESSORIES

EG-PE107		1001.C9 9648465210	B939 W5 41A3 206		
EG-PE108		1001.84 9611439480 9613590910	BOXER -2.5 D/TD Dj5 / DJ5T BOXER -2.5 TD DJ5TED		
EG-PE109		1001.24	106 1.4D TUD3 8V SOHC 106 1.5D TUD5 8V SOHC	88/91 91/95	
EG-PE110		1001.91	206 - 1.9 D / 306 - 1.9 D Dw8 (WJY - WJZ) 306 - 2.0 D Dw8 EXPERT/PARTNER/BERLINGO/ JUMPY/XSARA- 1.9 D DW8 (WJY - WJZ) PARTNER/EXPERT - 2.0 D DW8	98 - 98 - 98- 99-	
EG-PE111		1001.92	206/307/406/607/806/ EXPERT 2.0TD DW10(HDI)	98-	
EG-PE112		1001.69	106 /206/306 XS- 1.6 / 206 - 1.6 8V / 206 RALLY TU5JP 106 - 1.6 TUD5 205 - 1.6 TU (BLOCK CAST-IRON) 309 - 1.6 TU (BLOCK CAST-IRON) 405 TU3-2/TU3 INJECTION		
EG-PE113		1001.X1			

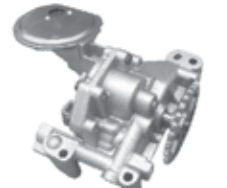

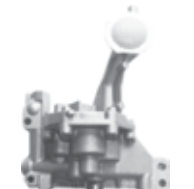

OIL PUMP

EGNO. PHOTO OEM NO. APPLICATION YEAR ACCESSORIES



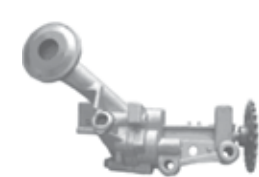
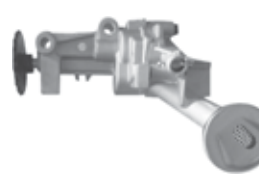



EG-PE114		1001.C7 1001.E0 9642180580	Fiat Citroen C4 C5 C8 Peugeot Lancia 206 CC 307 406 407 607 806 807 Expert 2,0 16V RFN EW10J4 Fiat Citroen C5 XSARA Peugeot 406 407 SW 1.8 16V 6FZ EW7J4		
EG-PE115		1001.77	306-1.8-8V 1800-XU7JP/LFZ 405-2.0i 2000	1993-	
EG-PE116		1001.C0			
EG-PE117		1001.E1	PEUGEOT EXPERT 2.0D ENG.DW10BTED.W4 DW10CTED	1999	
EG-PE118		1001.E2 1001.C1	DW8B		
EG-PE119		1001.87	106/206-1.6-16V 1600 TU5J4	1996-	
EG-PE120		1001.A9 1001.68	306 2.0D ME/ARG PARTNER 2.0D ENG.DW10TD 306/406 TD XUD9TE 1905cc 405 TD XUD9TE 1905cc	1999- 1993- 1992-1996	

OIL PUMP



EGNO.	PHOTO	OEM NO.	APPLICATION	YEAR	ACCESSORIES
EG-PE121	 Chain Gear:25 Teeth	9673506480 9808231280	Peugeot 208 -B 1.2 12V HMZ HM01 EB2 VTI/ 82PK		







EGNO.	PHOTO	OEM NO.	APPLICATION	YEAR	ACCESSORIES
EG-RE101		7700598323 7701585084 770692922 7701465119 7701465761	R21 2.0 DIESEL/TXE-TXI 12 V 2.0 2.2/1.8DIESEL FUEGO TX/GTX 2.0; R18 2.1 DIESEL; VANMASTER2.1D; TRAFIC 2.1D/2.2D; R21 2.1TD R182.1TD; R182.2L; R252.0; R25 2.2L; R202.1TDR302.1TD	86-94 81-86 84-93 80/84	
EG-RE102	 Chain Gear: 24 Teeth	7700600252 7701693577	MEGANE HATCH RXE 2.0/ SEDA RT 2.0/ SEDA RXE 2.0SCENIC RT 2.0/ RXE 2.0 SCENIC RXE EGEUS 2.0 PARA MOTORES 4 CIL. COM ENGRNAGEM DE ACIONAMENTO DE 24 DENTES	98 99 2001	
EG-RE102D	 Chain Gear: 20 Teeth	8200783526			
EG-RE103		7700697238 7701590269 7701611364 7700864218 7700859570 4401611364 7700703319 7700855138	R11 1.7 F2N F3N; R11 1.6D F8M; R11 GTX ; R9 1.7 F2N/F3N; R19 1.9DF8Q; R5 1.6DF2N-F3N; R9 1.7D F2M VAN EXPRESS 1.9D F8Q CLIO1.7 F2N; CLIO1.8 16V F7P	84-89 93 90-95	
EG-RE104		7701508491 7702057612 7701507593 7701506600	RENAULT CLIO 1.1 RENAULT 5 0.8/0.85/1.0/1.1/1.3/1.4 RENAULT 7 RENAULT 12 1.3/1.6 PARA MOTORES 4 CIL.	90/97 72/85 74/78 70/80	
EG-RE105		7005118923 101558187 7701588187	R9 1.4 C3J; VAN EXPRESS 0.9 C1C; ENCORE 1.4 1397; ALLIANCE 1.4 1397; R18 1.4 847-C1J, A5L-A7L; R18 1.6 847-CJ1-A5L R11 1.4 C1J-C2J-C3J; CLIO 1.1 C1E; CLIO 1.2 E5; CLIO 1.4 E6/E7; TWINGO 1.2 1237	83/87 90-95	
EG-RE106		101458594 7701458594 7701455221			

EGNO. PHOTO OEM NO. APPLICATION YEAR ACCESSORIES







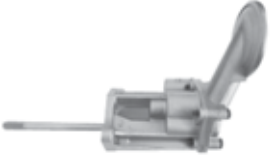

EG-RE107		7702247261 7702080844	FAIRWAY		
EG-RE108	 Chain Gear: 24 Teeth	7701643206 7700600120 7700600122	E7J, RENAULT19, 1600CC E7F E5F E6J C3J	90	
EG-RE109	 Chain Gear: 24 Teeth	7701693575	RENAULT CL 10-RN 1.6RT EXPRESS RL 1.6 KANGOO RL/RN 1.6 MEGANE RN/RT 1.6	90/01 2000 2000 1998	
EG-RE110	 Chain Gear: 24 Teeth	7701693578 7700600575	CLIO MEGANE 1.6I K4M EXPRESS KANGOO 1.6I		
EG-RE111	 Chain Gear: 24 Teeth	8200783524	Scenic-Privilege 2.0 16V/2.0 16V Aut Grand Scenic-Dynamique 2.0 16V/2.0 16V Aut Megane Sedan-2.0 16V/2.0 16V Aut Megane Grand Tour-2.0 16V/2.0 16V Aut Megane Coupe Cabriolet-2.0 16V Aut Para motores 4 CIL./For 4 CYL. engines	2004- 2008- 2005- 2007- 2007-	
EG-RE112		9607149010	Peugeot J5 Bus 280P 2.5 D 2498 ccm, 54 KW, 73 PS Peugeot J5 Bus 290P 2.5 TD 2500 ccm, 70 KW, 95 PS Peugeot J5 Bus 290P 2.5 TD 4x4 2500 ccm, 70 KW, 95 PS Peugeot J5 Kasten 280L 2.5 DT 2498 ccm, 70 KW, 95 PS Peugeot J5 Kasten 290L 2.5 DT 4x4 2500 ccm, 70 KW, 95 PS Peugeot J5 Pritsche/Fahrgestell 290L 2.5 TD 2500 ccm, 70 KW, 95 PS	1981-1990 1990-1994 1990-1994 1981-1990 1990-1994 1990-1994	

EGNO. PHOTO OEM NO. APPLICATION YEAR ACCESSORIES

EG-RE113	 Chain Gear: 24 Teeth	7700600574	RENAULT LAGUNA MK1 CLIO 1.6 16V F8Q		
EG-RE114	 Chain Gear: 22 Teeth	7700600532	RENAULT MEGANE 1.4 16v	2003-2006	
EG-RE115	 Chain Gear: 22 Teeth	8200101970 8200227686	CITO KANGOO 1600CC	2001	
EG-RE116	 KANGOO	7700864571 7700164191	TWINGO 1300CC KANGOO	1998 2000	
EG-RE117	 TWINGO/LOGAN/SANDERO 1.0	8200234757	RENAULT CLIO/KANGOO/ TWINGO/LOGAN/SANDERO 1.0		
EG-RE118	 Chain Gear: 24 Teeth	7701693576	RENAULT CLIO-RN 1.6 16V CLIO 1.6 Si 16V-RT SCENIC 1.6-16V-RT SCENIC ALIZE 1.6 16V	2001- 1999- 2001-	









EGNO.	PHOTO	OEM NO.	APPLICATION	YEAR	ACCESSORIES
EG-RE119	 Chain Gear: 24 Teeth	8200741642			
EG-RE120		8200251904	CLIO HATCH/SEDAN RN 1.0 16V/RT 1.0 16V CLIO -1.1i 16V D4F702/706/708/712/716/722 CLIO -1.2i 16V D4F712/714 SANDERO-1.0 16V D200/700/706/712/720/752/760 MODUS-1.1i 8V D7F LOHAN-1.0 16V Hi-FLEX	2001- 2001- 2001- 2001- 1998- 2008-	
EG-RE121	 Chain Gear: 22 Teeth	8200698014 8200227688	Renault LOGAN/SANDERO-1.6 8V Hi-TORQUE Renault Clio D Logan 1.4/1.6 K7M	2008-	
EG-RE122	 Chain Gear: 20 Teeth	150157688R 8200345633 8200346592 8200345757	VAUXHALL VIVARO TRAFIC PRIMASTAR 2.0 CDTI M9R		
EG-RE123	 Chain Gear: 22 Teeth	8200591428	Sandero-1.6 16V Hi-Flex Logan-1.6 16V Hi-Flex Clio-1.6 16V Hi-Flex Scenic-1.6 16V Hi-Flex Megance Sedan-1.6 16V Hi-Flex Megance Grand Tour-1.6 16V Hi-Flex Kangoo-1.6 16V Hi-Flex Para motores 4 CIL./For 4 CYL. engines	2008- 2008- 2005- 2005- 2006- 2006- 2007-	
EG-RE124	 Rotor Thickness 31mm	7701454706			
EG-RE125		7702057612SS	CILO 1.4		

OIL PUMP







EGNO.	PHOTO	OEM NO.	APPLICATION	YEAR	ACCESSORIES
EG-SU101		1610073003 1610073001 1610073002 17400E78101AA	JEEP LJ80 0.8 F8A SJ40/F10A JEEP SC100 F10A-SJ410 SANTANA 1.0 F10A-SJ410 SUPER CARRY 1.0 F10A ST-100,T2,T5,SJ410 SL410,PRONTO ST308 ST-90,NEW CARRY	1978 1982 82/90 1986	
EG-SU102		16100M60A00	JIMNY,SJ413,SWIFT 1.3 8V SOHC G13A 1325CC ESCUDO,SWIFT,VITARA 1.3i 16V SOHC G13B 1299CC ESCUDO,SWIFT,VITARA 1.6i 16V SOHC G16B 1590CC	83 86 86	
EG-SU103		15010AA095	SUBARU BAJA H4 2.5L FORESTER H4 2.5L IMPREZA H4 2.0L IMPREZA H4 2.2L IMPREZA H4 1.8L LEGACY H4 2.5L LEGACY H4 2.2L OUTBACK H4 2.5L	05-03 05-98 05-02 1998 97-93 05-99 99-91 05-00	<input checked="" type="checkbox"/> Special-shaped Ring 
EG-SU104		1610082821 1610082822 1610082825 1610082827 1610082829 1610082843	SWIFT SJ413 SF413	85/95	
EG-SU105		1610060811 1610060813 1610082810 1610060810 1610060815 1610085600 1510060814 1510060819 1610060A00 1610082826 102510015 96065377	GEO TRACKER L4 1.6L SUZUKI ESTEEM L4 1.6L SUZUKI SIDE KICK L4 1.6L	98-89 97-95 95-92	<input checked="" type="checkbox"/> Iron Gasket 
EG-SU106	 Chain Gear:36 Teeth	1610065D00	CHEVROLET TRACKER 2.0L DOHC J20A ENGINE SUZUKI AERIO 2.0 DOHC J20A ENGINE SUZUKI ESTEEM GL, GLX 1.8 DOHC G18K J18A ENGINE SUZUKI SIDEKICK SPORT 1.8 DOHC G18K J18A ENGINE SUZUKI VITARA 2.0 DOHC J20A ENGINE SX4 2.0 DOHC J20B ENGINE	1999-2003 2002-2003 1999-2002 1996-1998 1999-2003 2007-2010	
EG-SU107		1610069GE9000	Suzuki L4 1.5L DOHC Swift	2007-2011	

OIL PUMP

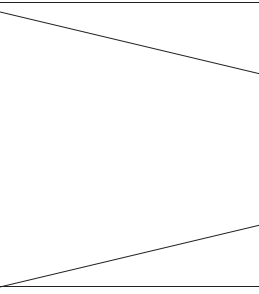





EGNO. PHOTO OEM NO. APPLICATION YEAR ACCESSORIES

EG-TO101		1510019015 1510019025 1510019030	CARINA 1.6 8V-16V 4AGEL-4AFE COROLLA 1.6 16V-4AGEL /GELC MR2 1.6 16V4AGE	1984 1984 85/90	<input checked="" type="checkbox"/> Gasket  Iron Gasket 
EG-TO102		1510015040 94851577	1AC,3AC,4AC,4ALC,4AGE 4AGELC,4AF,4AFE,GEO GM IMPORTS 1500CC 1600CC	80/97	
EG-TO103		1510015050 94855908	1AC,3AC,4AC,4ALC,4AGE 4AGELC,4AF,4AFE,GEO GM IMPORTS 1500CC 1600CC	80/97	
EG-TO104		1510035020 1510035030 M146	CRESSIDA 2300RX 70, HILUXERN-50-55(ME); LANDCRUISER 2 R.J70; 22RE/21R/22R/22REC/22RTE C PICKUP 2366CC;CELICA	85/95	<input checked="" type="checkbox"/> Special-shaped Ring 
EG-TO105		1511071010	HILUX 1Y,2Y,3Y,4Y 2300CC VAN 2000CC HILUX/SRX 2200CC HIACE 16 SEATER VENTURE 2200cc DYNA PETROL	1983-1989 1984-1989 1985-1986 1987- 1994- 1994-	
EG-TO106		1510071010 M159	VAN 3YEC 1998CC VAN 4YEC 2237CC 2Y,YX70 2300CC	1984-1985 1986-1989 1985	

EGNO. PHOTO OEM NO. APPLICATION YEAR ACCESSORIES





EG-TO107		1510064032 1510064011 1510064030	COROLLA 1C 16mm	1982	
EG-TO108					
EG-TO109		1510063010 T510074060	CAMRY 2000CC CAMRY 2 SELC, 3SFE, 3SGELC, CELICAAMR2	83/99	
EG-TO110		1130158010	PASEO 16V DOHC WITHOUT 1995 CALIFORNIA EMMISSION,5EFE 1497CC	92/95	
EG-TO111		1510011050	TERCEL 12VALUE 3E,3EE 1456CC TOYOTA 2EL 1295CC	87/94 88-95	
EG-TO112		151000D021 151000D010 151000D020 1510022020 1510022021 1510022040 1510022041	COROLLA 1ZZFE 1794CC	1998-2005	<input checked="" type="checkbox"/> Iron Gasket 

EGNO. PHOTO OEM NO. APPLICATION YEAR ACCESSORIES

EG-TO113		15100OH010 1510028020 15100OH060 15100OH020	SCION TC L4 2.4L CAMRY L4 2.4L HIGHLANDER L4 2.4L RAV4 L4 2.4L SOLARA L4 2.4L	2005 05-02 05-01 05-04 05-02	
EG-TO114		1510064040 1510064042 1510064041 1510064020 1510064021	COROLLA 2C,CE95 9mm	89-91	
EG-TO115		1510062020 1510062030 M204	CAMRY,2VZFE,3VZFE F1; DOHCV6 2507CC;2958CC	88/91 92/93	
EG-TO116	 Chain Gear:29 Teeth	1611485FA2 1610085FA2 1610085FA0 1610085FA1	CHEVROLET TRACKER V6-2.5L SUZUKI GRAND VITARA V6-2.5L SUZUKI GRAND VITARA V6-2.7L SUZUKI VITARA V6-2.5L SUZUKI XL-7 V6-2.7L	04-01 05-99 08-01 2004 06-02	<input checked="" type="checkbox"/> O-ring 
EG-TO117		1510061050 1510061010 1510061011 M153	2F, LAND CRUISER LANDCRUISER 4.2-2F FJ56-FJ60	84/85 1976	
EG-TO118		1510025020 M94C	CHARMANT 1.6 2T-2TC CHARMANT 1.8 3T-3TC COROLLA 1T,2T,3TC 1.6	1974 1980 71-82	

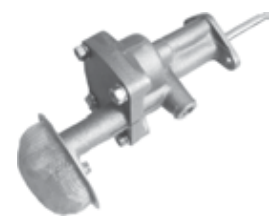
OIL PUMP

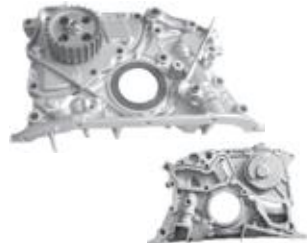
EGNO. PHOTO OEM NO. APPLICATION YEAR ACCESSORIES

EG-TO119		1510070011			
EG-TO120		1510043700			
EG-TO121		1510015020 94846081 M254	COROLLA2AL/4AL 1300/1500 TERCEL 3AC, 4AF	1984	
EG-TO122		1510074050 M216	CELICA RAV4,3SFE 2000CC	1996-2000	
EG-TO123		1510015060 94853635 M200	CORLLA 4AFE DOHC GEO GM IMPORTS 1600CC	93/97	
EG-TO124		1510011020	2E		

OIL PUMP







EGNO. PHOTO OEM NO. APPLICATION YEAR ACCESSORIES

EG-TO125					
EG-TO126		1510038010 M157			<input checked="" type="checkbox"/> Special-shaped Ring
EG-TO127		1510036010			
EG-TO128		1510038021 1510038020 1510035010 M145			<input checked="" type="checkbox"/> Special-shaped Ring
EG-TO129		1510065020 M184	3VZE V6,PICKUP 5100 4RUNNER 3000CC	1988-1995	<input checked="" type="checkbox"/> Gasket
EG-TO130		1130175021	3RFE R2N200 FR-TO:0106 FOR ENGINE:3RZ HILUX 2WD HIACE LAND CRUISER PRADO COASTER 4RUNNER DYNA200	1997-2002	

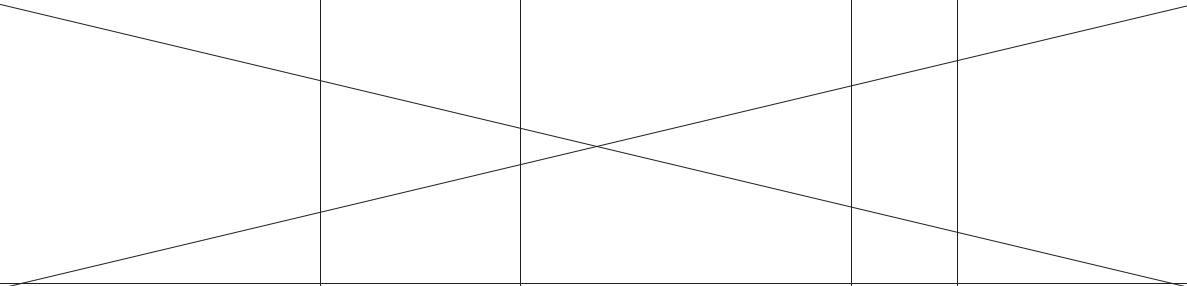
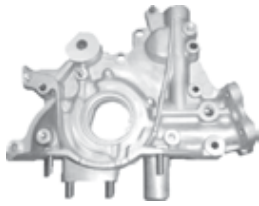





EGNO. PHOTO OEM NO. APPLICATION YEAR ACCESSORIES

EG-TO130A		OP939			
EG-TO131		1510016070 M217	Toyota Celica 1.8L 1762CC I4 GAS DOHC Naturally Aspirated Toyota Corolla 1.8L 1762CC I4 GAS DOHC Naturally Aspirated	1996-1997 1995-1997	<input checked="" type="checkbox"/> O-ring
EG-TO132		OPT049 OP968	Lexus ES350/GS350/IS350/ RX350 3.5L 3456CC V6 GAS DOHC Naturally Aspirated Toyota Avalon/Camry/Sienna/ RAV4 3.5L 3456CC V6 GAS DOHC Naturally Aspirated Lexus IS250 2.5L 2499CC V6 GAS DOHC Naturally Aspirated Lexus RX450h/Lexus GS450h/ Toyota Highlander 3.5L 3456CC V6 ELECTRIC/GAS DOHC Naturally Aspirated	2007-2013 2007-2013 2007-2013 2007-2013	<input checked="" type="checkbox"/> Special-shaped Ring O-ring Rotors
EG-TO133		OPT047 OP969	Toyota 4Runner 4.0L 3956CC 241Cu. In. V6 GAS DOHC Naturally Aspirated Toyota Tundra 4.0L 3956CC 241Cu. In. V6 GAS DOHC Naturally Aspirated Toyota Tacoma 4.0L 3956CC 241Cu. In. V6 GAS DOHC Naturally Aspirated Toyota FJ Cruiser 4.0L 3956CC 241Cu. In. V6 GAS DOHC Naturally Aspirated	2003-2009 2005-2009 2005-2013 2007-2009	<input checked="" type="checkbox"/> Special-shaped Ring O-ring Rotors
EG-TO134		1131036020	Lexus ES Toyota Highlander II Toyota RAV4 Toyota Venza 2.5I 2ARFE	2012- 2007-2013 2006-2013 2009-	
EG-TO135		1131154022	TOYOTA 4RUNNER 2L TOYOTA HIACE Lh11	1983-1987	

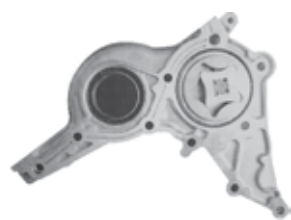







EGNO. PHOTO OEM NO. APPLICATION YEAR ACCESSORIES

EG-TO136		1130235010	TOYOTA 4RUNNER 22RE 2400cc	1985-1995	
EG-TO137					
EG-TO138		1510087111 1510087104	DAIHATSU model:S-89		
EG-TO139		1510087113	DAIHATSU model:S-91		
EG-TO140		1510073030			
EG-TO141		1131075073 1131075070 1131075071 113100C021	TOYOTA HILUX DYNA 2400cc LAND CRUISER 2TRFE	2004-	<input checked="" type="checkbox"/> Bolt  <input type="checkbox"/> Water Pump  <input type="checkbox"/> Iron Gasket 

EGNO. PHOTO OEM NO. APPLICATION YEAR ACCESSORIES









EG-TO142		OPT032			
EG-TO143		OPT042			
EG-TO144		1510074060	TOYOTA GAMRY 2.0L 1998CC 122Cu. In. I4 GAS DOHC Naturally Aspirated TOYOTA CELICA 2.0L 1998CC 122Cu. In. I4 GAS DOHC Naturally Aspirated TOYOTA CELICA/MR2 2.2L 2164CC I4 GAS DOHC Naturally Aspirated	1987-1991 1987 1992-1995	
EG-TO145		113100T050	COROLLA 1.6/1.8		
EG-TO146					
EG-TO147		1131154050 1131154051 1131154052 1130154032	TOYOTA 4RUNNER LN SERIES 3L DIESEL ENGINE 2.8L TOYOTA HILUX LN SERIES 3L DIESEL ENGINE 2.8L TOYOTA DYNA LY161 SERIES 3L DIESEL ENGINE 2.8L TOYOTA HIACE LH SERIES 3L DIESEL ENGINE 2.8L	1986-1997 1988-1997 1986-1997 1986-2001	

EG NO. PHOTO OEM NO. APPLICATION YEAR ACCESSORIES

EG-VW101	 Chain Gear:32 Teeth	030115105C 030115105E 030115105D	Golf / Jetta / Vento - 1.05 e 1.4 Polo - 1.3 Polo / Derby - 1.05 e 1.4 Seat Ibiza / Cordoba 1.05 e 1.3 Seat Ibiza / Cordoba 1.4 For 4 cyl. engines	86/94 87/94 85/94 93/ 93/95	
EG-VW102		026115105.5 027115105 027115105E 055115105D 049115105A 055115105A M79G	Golf/ Jetta - 1.5/1.6 Golf/ Jetta/ Vento - 1.8 Passat - 1.6/ 1.8 Seat - Ibiza/Cordoba 1.6/ 1.8 Seat - Toledo 1.6/ 1.8 Golf / Vento - 1..6 Golf - GLM (Mexico) Golf - GLA (Germany)	74/83 75/91 82/97 88/96 93/ 91/96 94/97 96/98	<input type="checkbox"/> Oil Baffle 
EG-VW103		026115105 026115105B 026115105.3 M226	Audi 80 - 1.6 Audi 100 - 1.6 Audi 100 - 1.8/ 1.3 Passat - 1.3/ 1.8 Santana - 1.3/ 1.8 Audi 80 - 1.3/ 1.8	91/95 92/94 82/91 84/88 84/88 84/91	<input type="checkbox"/> Oil Baffle 
EG-VW104		027115105B M244	Golf - GLX 2.0/ GLX 2.0 Mi GTi 2.0/ Cabriolet 2.0 Golf - GL 1.8/ GL 1.8 Mi Seat - Cordoba GLX 1.8 /SXE 1.8 Seat - Ibiza GLX 1.8/ SXE 1.8 Seat Alhambra 2.0 Passat GL 2.0 Variant GL 2.0 Vento 2.0	92/98 82/ 94/ 93/ 96/ 90/97 90/97 91/97	<input type="checkbox"/> Oil Baffle 
EG-VW105		068115105BN	Golf 1.6 TD JR, MF, RA, SB Jetta 1.6 TD JR, MF, RA, SB Passat 1.6 TD RA, SB(With ABS) Chasis No. 31-J-000001	88/92 88/92 88/93	
EG-VW106		027115105C 027115105A 068115105AG 068115105Q M79E	Golf 2 - 1.8 Gti 16v Golf 2 - 1.8 Gti 16v cabrio Scirocco - 1.8 GT 16v Scirocco-1.8 GTX 16v Jetta 2 - 1.8 GT 16v Golf/ Jetta1.5/ 1.6 Seat Toledo1.8 Seat Ibiza 1.8 Cordoba - 1.8 Passat - 1.8	86/91 85/92 85/92 76/91 91/94 94/96 94/96 88/92	







OIL PUMP

EG NO. PHOTO OEM NO. APPLICATION YEAR ACCESSORIES

EG-VW107		068115105AN 068115105AE 068115105P 068115105H 068115105S 068115105D M79D	GOLF 1/GOLF 2 - 1.5 DIESEL/1.6 DIESEL JETTA 1/ JETTA 2 - 1.6 DIESEL JETTA 1/ JETTA 2 - 1.6 TURBO DIESEL	79/91	<input type="checkbox"/> Oil Baffle 
EG-VW108		028115105G 068115105BK 95VW6600BA	80 1.9 TD 1Y TURBO DIESEL GALAXY 1.9 TD TURBO DIESEL ALHAMBRA 1.9 D 1Y VENTO 1.9 D 1Y (NON ABS) VENTO 1.6 D JR PASSAT 1.9 D 1Y, 1.6 D JR JETTA 1.9 D 1Y, 1.6 D JR GOLF 1.9 D 1Y, 1.6 D JR	88 95 91 88	<input type="checkbox"/> Oil Baffle 
EG-VW109		021115105B 021115153D 021115109B	LEON (1M1) 2.8 CUPRA 4 ALHAMBRA (7V8, 7V9) 2.8 V6, 2.8 V6 4MOTION	1999 1996	
EG-VW110		068115105AQ 068115105AR 068115105BP 068115105J	TRANSPORTER III BUS 1.6 TD SYNCRO, 1.9 SYNCRO, 2.1 SYNCRO TRANSPORTER III KASTEN / BOX 1.6 TD SYNCRO, 1.9 SYNCRO, 2.1 SYNCRO TRANSPORTER III PRITSCHKE / PICK UP1.6 TD SYNCRO, 1.9 SYNCRO, 2.1 SYNCRO	79/92 79/92 79/92	
EG-VW111		068115105AP 068115105AC 068115105AD 068115105N 068115105R 068115105.3	PASSAT (32/33) 1.3,1.6 PASSAT VARIANT / WAGON (32/33) EXCEPT: 1.5, 1.5 D PASSAT (32B)1.6,1.6D,1.6TD STUFENH/SEDAN(32B)1.6TD PASSAT VARIANT/WAGON (32B)1.6,1.6D,1.6TD SANTANA (32B)1.6,1.6D,1.6TD	73/80 73/81 80/88 85/88 80/89 81/84	
EG-VW112		058115105C M366	PASSAT - 1.8 20V PASSAT 1.8 20V TURBO VARIANT - 1.8 20V VARIANT - 1.8 20V TURBO PASSAT - 2.0 20V TURBO GOL - 2.0 16V	96- 96- 96- 96- 96- 96-	







OIL PUMP

EGNO. PHOTO OEM NO. APPLICATION YEAR ACCESSORIES

EG-VW113		028115105M	PASSAT - 1.9 AUDI A4 - 1.9 AUDI A6 - 1.9	10-96/ 11-94/ 07-95/	
EG-VW114		037115105	PASSAT VARIANT / WAGON (35I) 1.8, 1.8 16V, 1.8 G60 PASSAT (35I) 1.8, 1.8 16V, 1.8 G60 JETTA II (19E) 1.8, 1.8 16V, 1.8 KAT, 1.8 GOLF II (19E) 1.8, 1.8 GTI, 1.8 GTI 16V, 1.8 GTI G60, 1.8 GTI G60; SYNCRO, 1.8 GTI KAT, 1.8 I KAT, 1.8 I; SYNCRO KAT, 1.8	88/97 88/96 84/92 83/92	
EG-VW115		053115105B 053115105C	GOL GTI - 2000 16V PARATI GTI - 2000 16V FOR AP 2000 4 CYL. ENGINE	96/00 96/00	
EG-VW116		026115105D	TRANSPORTER TYPE 4 - 1.9 DIESEL FOR 4 CYL. ENGINE	1990	
EG-VW117		029115105.7 029115105.1	GOL - 1000/ GOL 1000I PLUS GOL - CL 1.6 VOYAGE - CL 1.6 SAVEIRO - CL 1.6 PARATI - CL 1.6 FOR AE 1.0/ AE 1.6	92/96 89/94 89/93 89/93 89/93	<input checked="" type="checkbox"/> Gasket 
EG-VW118		026115105A 026115105.6 053115105.1 026115105.4	80 (89, 89Q, 8A, B3) 2.0E, 2.0E QUATTRO, 2.0 QUATTRO 80 (8C, B4) 2.0, 2.0 E, 2.0 E QUATTRO 80 AVANT / WAGON (8C, B4) 2.0, 2.0 E CABRIO (8G7, B4) 2.0 E COUP (89, 8B) 2.0 100 (4A, C4) 2.0, 2.0 E, 2.0 E QUATTRO A6 AVANT / WAGON (4A, C4) 2.0	86/91 91/94 91/96 91/00 88/96 90/94 94/97	

OIL PUMP

EGNO. PHOTO OEM NO. APPLICATION YEAR ACCESSORIES

EG-VW119		028115105J 068115105BL	80(89,89Q,8A,B3)1.6TD,1.9D 80(8C,B4)1.9TD,1.9TDI 80AVANT/WAGON(8C,B4)1.9TDI 90(89,89Q,8A,B3)1.6TD A6(4A,C4)1.9TDI A6AVANT/WAGON(4A,C4)1.9TDI	86/91 91/94 91/96 87/91 94/97 94/97	
EG-VW120		026115105.1 049115105H	PASSAT GLS/ VILLAGE/ TS/ GTS/ POINTER 1.6/ 1.8 GOL BX/S/CL/LS/GT/GTS1.6/1.8 VOYAGES/CL/LS SUPER/GLS1.6/1.8 PARATI S/ CL/ LS 1.6/ 1.8 SAVEIRO S/ CL/ LS - 1.6/ 1.8 SANTANA CS/CL/CD/CG/GLS1.8 QUANTUM CS/CL/CD/CG/GLS1.8	84/89 85/89 84/89 84/89 84/89 85/89 86/89	
EG-VW121		068115105.5	KOMBI - STD 1.6 DIESEL KOMBI - PICK-UP 1.6 DIESEL KOMBI - FURGAO 1.6 DIESEL PARA MOTORES 4 CIL.	82/86	
EG-VW122		028115105D	TRANSPORTER IV BUS 1.9 D, 1.9 TD TRANSPORTER IV KASTEN BOX 1.9 D, 1.9 TD TRANSPORTER IV PRITSCHKE PICK UP 1.9 D, 1.9 TD	09/1990 07/1990 07/1990	
EG-VW123		051115105A	PASSAT 2.0 16V 3A2 35I PASSAT 2.0 16V 3A5 35I GOLF III 2.0 GTI 16V CORRADO 2.0I 16V SEAT 1L 2.0I 16V SEAT 6K1 2.0I 16V	01.94/09.93 01.94/09.93 08.92/08.97 08.91/12.95 11.93/03.99 08.96/08.99	
EG-VW124	 Chain Gear:30 Teeth	032115105G	GOL-1000I/1000I PLUS/1000MI GOL-1000 MI PLUS 16V PARATI-1000 MI 16V MOTOR:AT-4CYL	1996-1998 1997-1998 1997-1998	







OIL PUMP

EGNO.	PHOTO	OEM NO.	APPLICATION	YEAR	ACCESSORIES
EG-VW125		068115105.12	KOMBI-STD 1.6 DIESEL KOMBI-PICK UP 1.6 DIESEL KOMBI-FURGAO 1.6 DIESEL GOL-1.6 DIESEL SAVEIRO-1.6 DIESEL	81/86 97/98 84/98 84/89 96/97	
EG-VW126		056115105A	PASSAT-LS/TS/GLS/LSE /GTS-1.5/1.6 GOL-S/CL/CS-1.5/1.7 VOYAGE-S/CL/LS-1.5/1.6 PARATI-S/CL/LS-1.5/1.6 SAVEIRO-S/CL/LS-1.5/1.6	74/83 81/83 82/83 82/83 82/83	
EG-VW127		029115105.8	VW LOGUS CLI/CL/GL 1.6	92/94	<input checked="" type="checkbox"/> Gasket
EG-VW128		041115105	VOLKSWAGEN CABRIO - 2.0 ACE VOLKSWAGEN COUPE - 2.0 6A/ACE VOLKSWAGEN GOL Gti 2.0 16V VOLKSWAGEN PARATI Gti 2.0 16V AUDI 80 - 2.0 / 80 QUATTRO -2.0 6A/ACE AUDI 80 AVANT/80 AVANT QUATTRO/100/ 100 AVANT/100 AVANT QUATTRO/100 QUATTRO/A6/A6 AVANT/A6 AVANT QUATTRO/A6 QUATTRO - 2.0 ACE	1996- 1996- 1996- 1997- 1996- 1996- 1996-	
EG-VW129	 Chain Gear:30 Teeth	03C115105L	VW L4 1.6L (1598cc) DOHC 16 Vál., Vento	2013-2015	
EG-VW130		028115105L 049115105.1	SKODA FELICIA I (6U1) SKODA FELICIA I FUN (797) SKODA FELICIA I ESTATE (6U5)	1994-1998 1997- 1995-1998	<input type="checkbox"/> Oil Baffle







OIL PUMP

EGNO.	PHOTO	OEM NO.	APPLICATION	YEAR	ACCESSORIES
EG-VW131		03D115105G	VW SEAT/IBIZA/POLO/FABIA 1.2 12V 3 CYLINDER AZQ ENGINE VW SEAT/SKODA/IBIZA IV/FABIA/ POLO 9N 1.2 ENGINE BBM	2002-2008 2006-2014	
EG-VW132		026115105.5			
EG-VW133		027115105.5	Apollo - GL 1.8/GLS 1.8 Logus -Cli 1.8/CL 1.8/Gli 1.8/GL 1.8/ GLS 1.8/GLSi 2.0/ GLS 2.0/ Wolfsburgo Edition 2.0i Pointer - Cli 1.8/ CL 1.8/Gli 1.8/ GL 1.8/ Gli 2.0/GL 2.0/GTI 2.0 Polo - Classic 1.8 Mi Novo Polo-Classic 1.6/1.8 Inca/Caddy Argentino-1.6 EFI Van-1.6 L EFI	1990-1992 1993-1997 1994-1996 1997- 1998-2001 1998- 1998-	
EG-VW134		026115105B	The only difference between EG-VW134 and EG-VW103 is the shaft	2006-	
EG-VW135	 Sprocket Gear:22 Teeth	06J115105AC 06J115105AB 06J115105R	VW GOLF 2.0TSI(147KW) VW JETTA 2.0TSI(125KW)/(147KW) VW PASSAT B6 1.8TSI(118KW)/ 2.0TSI(147KW) VW TIGUAN 2.0TSI(147KW) VW EOS 2.0TSI(147KW) VW SCIROCCO 2.0TSI(147KW) SEAT LEON 1.8TSI (118KW) SEAT TOLEDO 1.8TSI (118KW) SKODA OCTAVIA 1.8TSI (118KW) SKODA SUPERB 1.8TSI (118KW) AUDI A3 1.8TFSI(118KW) 2.0TFSI (147KW) AUDI TT 2.0TFSI(147KW CCTA)	2007-2013 2006-2011 2006-2011 2008-2012 2009-2011 2009-2012 2006-2010 2005-2009 2004-2008 2008-2013 2004-2013 2007-2010	
EG-VW136	 Sprocket Gear:25 Teeth	07K115105Q	VW Beetle 2.5L L5 BPR/BPS VW Golf 2.5L L5 CBTA/CBUA VW Jetta 2.5L L5 CBTA/CBUA	2006-2010 2010 2008-2010	

OIL PUMP







EGNO.	PHOTO	OEM NO.	APPLICATION	YEAR	ACCESSORIES
EG-VW137					<input type="checkbox"/> Oil Baffle 
EG-VW138	 Sprocket Gear:35 Teeth	04E115109G	VW GOLF 1.4TSI	2015	
EG-VW139	 Sprocket Gear:40 Teeth	03F115105D	VW Seat/Audi L4 1.2L (1198cc) TSI SOHC 8 Vál. Polo, Ibiza, Cordoba, Audi A1	2007-2015	
EG-VW140		BAA115101	4 1.6L (1584cc) 8 Vál. Sedan FI	1992-2003	
EG-VW141	 Drive Gear:41 Teeth	070115103A 070115153 070115105A	VW 2.5TDI Diesel 2461cc AXD/ AXE/BAC/BLJ/BLK/BNZ/BPC/ BPD/BPE	2003-2010	

OIL PUMP







EGNO.	PHOTO	OEM NO.	APPLICATION	YEAR	ACCESSORIES
EG-01	 Drive Gear : 29 Teeth	8971473381 8971473382 8971473383	ISUZU 4HF1		
EG-02	 Drive Gear : 25 Teeth	T29			
EG-03		92061951 M308	Holden 253, 308 and 4.9L/ 5.0L V8 engines	1969	
EG-04	 Drive Gear : 19 Teeth	41314033 41314087 41314164 41314189 736617M91	Engine: A4.192 A4.203 AD4.203 Model: 50. 65. 155. 158. 165. 260. 560. 765		
EG-05	 Drive Gear : 19 Teeth	41314182 41314054	G4.236 4.212 4.236 4.248 4.248.2		
EG-06					







OIL PUMP

EGNO. PHOTO OEM NO. APPLICATION YEAR ACCESSORIES







EG-07			VOLVO		
EG-08	 Drive Gear : 21 Teeth	6206511201	6D95 KOMATSU		
EG-09					
EG-010		10118639	BUICK		
EG-011		194838	SCANIA	76/97	<input checked="" type="checkbox"/> Gasket 
EG-012		4L80E			

EGNO. PHOTO OEM NO. APPLICATION YEAR ACCESSORIES







EG-013		13461447 12763363 1346144 M181	Volvo Penta 230A, 230B, 250A, 250B		
EG-014			for India market		
EG-015			ROVER KV6		
EG-016					
EG-017		12606580 12584621 12606590 90537914	GM L4 2.2 SOHC, DOHC Astra, Zafira, Vectra	2000-2009	
EG-017B			GM L4 2.2L, 2.4L, DOHC 16 Vál. Ecotec, L61, Astra, Cavalier, Classic, Cobalt, HHR, Malibu, Alero, Pontiac G5, G6, Solstice, Sunfire (kit de Repuesto)	2000-2013	
EG-018					

EGNO.	PHOTO	OEM NO.	APPLICATION	YEAR	ACCESSORIES
EG-O19		1426449 1120646	SCANIA DS14		<input checked="" type="checkbox"/> Gasket 
EG-O20	 Drive Gear : 41 Teeth	070115103A 070115153 070115105A	VW 2.5TDI Diesel 2461cc AXD/ AXE/BAC/BLJ/BLK/BNZ/BPC/ BPD/BPE	2003-2010	
EG-O21		6136521210	KOMATSU S6D105 EXCAVATOR PC200-3		
EG-O22					
EG-O23	 Drive Gear : 44 Teeth				
EG-O24	 (L)Drive Gear : 23 Teeth (R)Drive Gear : 24 Teeth	3802278 3930338	CUMMINS 6CT(8.3)		





OIL PUMP

EGNO.	PHOTO	OEM NO.	APPLICATION	YEAR	ACCESSORIES
EG-O25		4132F012 41314175 70993817	PERKINGS		
EG-O26		12579555 12591997 12591990	BUICK REGAL 3.0		<input checked="" type="checkbox"/> Shaft 
EG-O27		GLP139 AHU1050 CAM4577	ALLEGRO 1.1 10H, METRO 1.0 99H MINI CITY, MAYFAIR 1.1 3 BOLT FIX SPADE DRIVE PUMP	1973	
EG-O28		12G793 12A303 GLP142	MINI 850, 948 MK I&II,A35, A40 1100 MK I&II,CLUBMAN 1000, MINI MOKE ELF,HORNET,KESTREL, MG MIDGET PEG DRIVE PUMP	1958	
EG-O29			LINCOLN AVIATOR V8-4.6L LINCOLN CONTINENTAL V8-4.6L LINCOLN MARK VIII V8-4.6L	05-03 02-95 98-95	
EG-O30		8125718850 12571885 OP3175 M355	BUICK RAINIER V8-5.3L CHEVROLET IMPALA V8-5.3L CHEVROLET MONTE CARLO V8-5.3L PONTIAC GRAND PRIX V8-5.3L SAAB 9-7X V8-5.3L GMC ENVOR V8-5.3L	2005-2007 2005-2007 2005-2007 2005-2007 2005-2007 2005-2007	

OIL PUMP



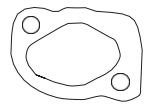



EGNO.	PHOTO	OEM NO.	APPLICATION	YEAR	ACCESSORIES
EG-O31		12612289 OP3172 DM1141 M365	Cadillac 6.2L 376Cu. In. V8 GAS OHV Supercharged Escalade 6.2L 376Cu. In. V8 FLEX OHV Naturally Aspirated	2007-2013 2007-2013	
EG-O32					
EG-O33					
EG-O34					
EG-O35		CAM6614 GLP110	METRO 1275 GT TURBO MG 1300 TURBO	1982-	
EG-O36		C217652 C217651 C0217652	JAGUAR XJ6 2.8/3.4/4.2 XK SERIES JAGUAR E TYPE 4.2 XK- SOVEREIGN 3.4/4.2	1969- 1965-	

OIL PUMP

EGNO.	PHOTO	OEM NO.	APPLICATION	YEAR	ACCESSORIES
EG-O37					
EG-O38		14018725 14058702 14086060 OP324 M98	Buick Century 2.2L L4 2190CC Oldsmobile Cutlass Ciera 2.2L L4 Chevrolet Corsica/Cavalier/Beretta 2.2L L4 Oldsmobile Firenza 2.0L L4 Chevrolet Corsica/Beretta/ Cavalier/Buick Skyhawk 2.0L L4	1993 1993 1990-1993 1987-1988 1987-1989	
EG-O39		10184977 10209660 8101849770 OP328 M248	Pontiac Sunfire 2.2L L4 2190CC	1995-2002	
EG-O40		OP3125	Chevrolet C1500/C2500/Astro 4.3L V6 Chevrolet C1500/C2500/Cadillac Brougham 5.0L V8 Chevrolet C1500/C2500/C3500/ Blazer/Corvette 5.7L V8 GMC G3500 5.7L/5.0L V8 GMC G3500 4.3L V6	1991-1995 1991-1995 1991-1996 1992- 1992-	<input checked="" type="checkbox"/> Gasket 
EG-O41		24576315 24577080 88958981 OP332 M205	CHEVROLET Cavalier 2.4L 2392CC 146Cu. In. I4 GAS DOHC Naturally Aspirated	1995-2002	
EG-O42					







OIL PUMP

EGNO. PHOTO OEM NO. APPLICATION YEAR ACCESSORIES

EG-O43		E43Z6600A E63Z6600A M102	Ford L4 2.3L 2.5L Topaz, Tempo, Taurus	1986-1994	
EG-O44		3237844 3238636 3238637 3241399 3241602 3242138 3242139 3242141 3243102 33002888 M81A	Chrysler-Jeep L6 3.8L (232), 4.2L (258), American Gramblin, Pacer, Jeep, Wagoneer	1964-1982	<input checked="" type="checkbox"/> Gasket 
EG-O45					
EG-O46					
EG-O47		3904826 475908 OP3174 M77	GMC K3500/K2500/G3500/C3500/P3500/Savana 3500/Chevrolet P30 7.4L V8	1994-2000	
EG-O48		OP3174HV M77HV	CHEVROLET 7.0(427) 8cyl. CHEVROLET 7.4(454) 8cyl.	1968-1998 1971-2000	





OIL PUMP

EGNO. PHOTO OEM NO. APPLICATION YEAR ACCESSORIES





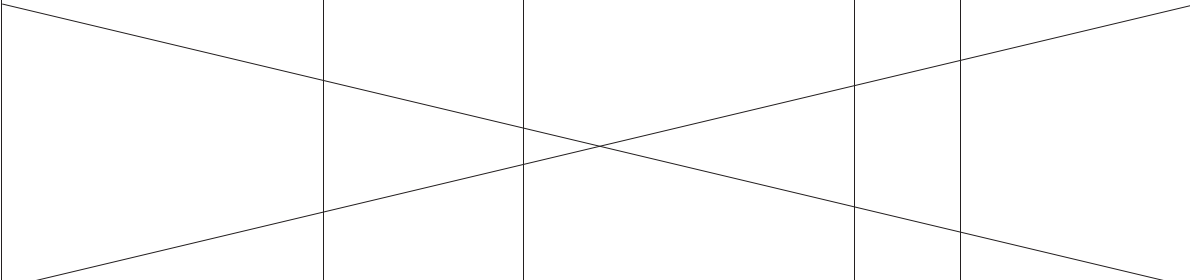
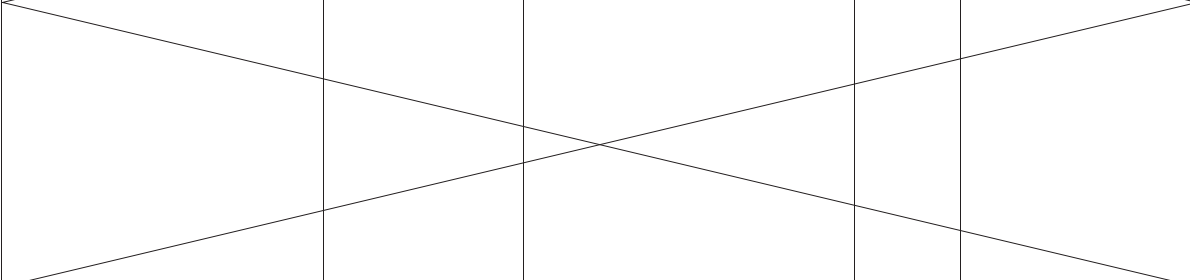



EG-O49		OP1140HV M72HV	Jeep Grand Wagoneer 5.2L 5211CC V8	1993	
EG-O50					
EG-O51					
EG-O52					
EG-O53					
EG-O54		OP4137			

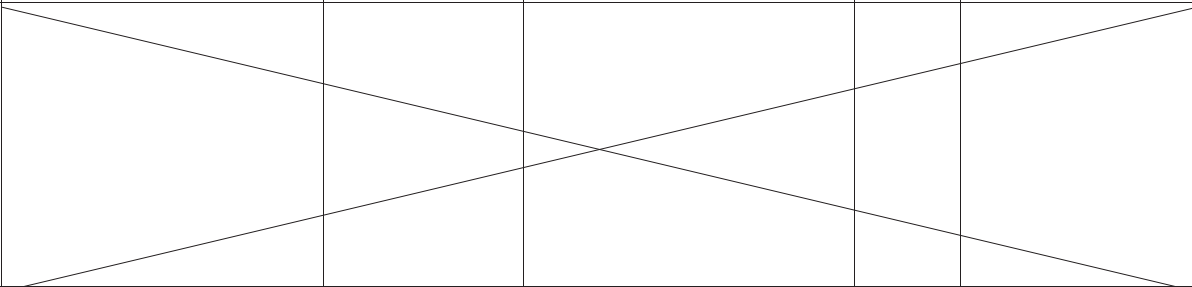





OIL PUMP



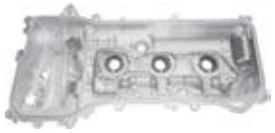

EGNO. PHOTO OEM NO. APPLICATION YEAR ACCESSORIES

EG-O55					
EG-O56					
EG-O57		10055849 10055850 12555284 14057041 3755420 3764547 3821979 M55	FORD SAFARI/SONOMA 4300cc	1990-1991	
EG-O58					
EG-O59					
EG-O60		3904826 475908 OP3174 M77	GMC K3500/K2500/G3500/C3500/ P3500/Savana 3500/Chevrolet P30 7.4L V8	1994-2000	<input checked="" type="checkbox"/> Spring 





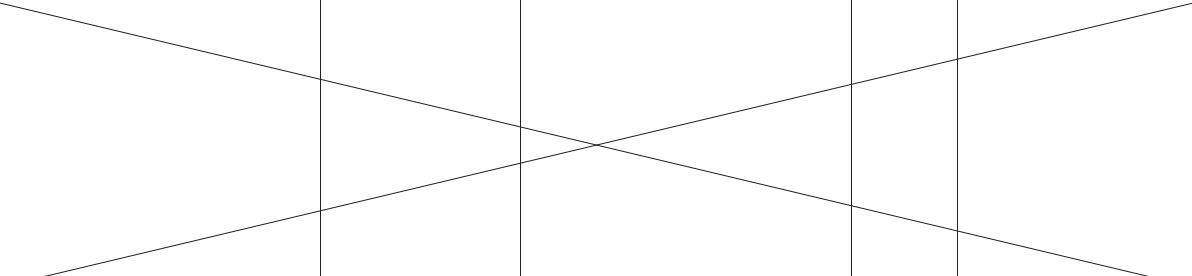

EGNO. PHOTO OEM NO. APPLICATION YEAR ACCESSORIES

EG-O61		83500826 83501486 10087696 10146802 14033065 14033227 14085460 8100876960 8101468020 8140854600 M95B	Buick Regal/Chevrolet/ Oldsmobile/Pontiac 3.1L 189 Cu. In. V6 GAS OHV Naturally Aspirated Chevrolet/GMC/Oldsmobile/ Pontiac 2.8L 173Cu. In. V6 GAS OHV Naturally Aspirated	1990 1988-1990	
EG-O62					
EG-O63	 Drive Gear : 57 Teeth	12363188 22538689 24571299 M136			
EG-O64		4F2Z6019AA F6ZZ6603AA OP4120 M246	MUSTANG 3800cc TAURUS, THAUNDERBIRD 3800cc TRUCK E-150, E250 2003-UP 4200cc TRUCK F-150 4200cc		<input checked="" type="checkbox"/> Special-shaped Ring  Cap  Plunger  Spring 
EG-O65		5L5Z6600AA F77Z6600AA M256S	Mazda B3000 3.0L V6	1994-2008	
EG-O66		41314178 41314078 41314187 M162	Perkins 3.152 3A.152 3D.152 3AD.152 3 Cyl DIESEL Engines		

EGNO.	PHOTO	OEM NO.	APPLICATION	YEAR	ACCESSORIES
EG-O67		L000050019			
EG-O68		CAM6036 AHU1048 GLP138	METRO 1.3 12H,1.3GT,ALLEGRO 1.3 ITAL 1.3 12V,MAESTRO 1.3 12H MARINA 1.3 12V,MONTEGO 1.3 12H MG METRO 1.3	1973- 1982-1989	
EG-O69		12G1128 12G2790 CHM140 GLP141	AUSTIN 1300 12H,MARINA 1.3 12V MG MIDGET,MINI COOPER S 1.3 RILEY KESTREL 1.3, MG1300 HEALEY SPRITE,HORNET 1.3 STAR DRIVE PUMP	1964-	
EG-O70		LPF000030	MG ROVER K SERIES ENGINE TO FIT MGF/TF, ZR, ZS, ZT AND ROVER 25,45 AND 75 ALSO FIT LAND ROVER FREELANDER Fit all K Series engine cars - 1.1, 1.4, 1.6, 1.8 and VVC		
EG-O71					
EG-O72		1071475046	55632-ZF6HP19 ZF6HP21, CENTER SUPPORT		







EGNO.	PHOTO	OEM NO.	APPLICATION	YEAR	ACCESSORIES
EG-O73					
EG-O74		OPK3138	CHEVROLET/GMC 2.9L L4/ 3.7 L5/4.2L L6	2007-2012	
EG-O75					
EG-O76					
EG-O77			MINI COOPER		
EG-O78					

EGNO. PHOTO OEM NO. APPLICATION YEAR ACCESSORIES

EG-O79	 <p>1512154020 1351954010 1512138010</p>				
EG-O80					
EG-O81		3433513063	Caterpillar E320C excavator S4K,S6K engine		
EG-O82					
EG-O83					
EG-O84	 <p>Drive Gear : 25 Teeth</p>	1510097401	4A13		







OIL PUMP

EGNO. PHOTO OEM NO. APPLICATION YEAR ACCESSORIES





EG-O85	 <p>Chain Gear : 20 Teeth</p>	15100B1010	4A15		
EG-O86					
EG-O87		3433523010 1786539	Caterpillar E320B, E320 EXCAVATOR		
EG-O88					
EG-O89		25189699 96992000 25193452	GM L4 1.2L (1249cc) DOHC 16 Vál. , Chevrolet Spark	2011-2015	
EG-O90		10008206 8132303 10036939 M62C	GM L4 2.5L OHV Pick Up, S10, S15		

OIL PUMP

EGNO. PHOTO OEM NO. APPLICATION YEAR ACCESSORIES

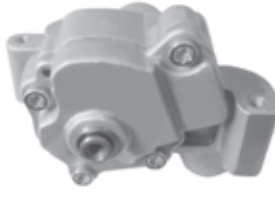
EG-O91					
EG-O92			Chevrolet		
EG-O93			Caterpillar E320C with inner cooler		
EG-O94		5I-7948	Caterpillar E200B		
EG-O95					
EG-O96		CO006	CLASSIC MINI FITS 850 / 998 / 1100CC engines- PIN DRIVE		

EGNO. PHOTO OEM NO. APPLICATION YEAR ACCESSORIES

EG-CHC101					
EG-CHC102			荣威 350		
EG-CHC103		G0610592KZ-12 G0610591UC-12			
EG-CHC104			BM15T		
EG-CHC105			BM15L		

